



Recycling and recovery routes of plastic solid waste (PSW): A review

S.M. Al-Salem*, P. Lettieri, J. Baeyens

Centre for CO₂ Technology, Department of Chemical Engineering, School of Process Engineering, University College London (UCL), Torrington Place, London WC1E 7JE, UK

ARTICLE INFO

Article history:

Accepted 4 June 2009

Available online 3 July 2009

ABSTRACT

Plastic solid waste (PSW) presents challenges and opportunities to societies regardless of their sustainability awareness and technological advances. In this paper, recent progress in the recycling and recovery of PSW is reviewed. A special emphasis is paid on waste generated from polyolefinic sources, which makes up a great percentage of our daily single-life cycle plastic products. The four routes of PSW treatment are detailed and discussed covering primary (re-extrusion), secondary (mechanical), tertiary (chemical) and quaternary (energy recovery) schemes and technologies. Primary recycling, which involves the re-introduction of clean scrap of single polymer to the extrusion cycle in order to produce products of the similar material, is commonly applied in the processing line itself but rarely applied among recyclers, as recycling materials rarely possess the required quality. The various waste products, consisting of either end-of-life or production (scrap) waste, are the feedstock of secondary techniques, thereby generally reduced in size to a more desirable shape and form, such as pellets, flakes or powders, depending on the source, shape and usability. Tertiary treatment schemes have contributed greatly to the recycling status of PSW in recent years. Advanced thermo-chemical treatment methods cover a wide range of technologies and produce either fuels or petrochemical feedstock. Nowadays, non-catalytic thermal cracking (thermolysis) is receiving renewed attention, due to the fact of added value on a crude oil barrel and its very valuable yielded products. But a fact remains that advanced thermo-chemical recycling of PSW (namely polyolefins) still lacks the proper design and kinetic background to target certain desired products and/or chemicals. Energy recovery was found to be an attainable solution to PSW in general and municipal solid waste (MSW) in particular. The amount of energy produced in kilns and reactors applied in this route is sufficiently investigated up to the point of operation, but not in terms of integration with either petrochemical or converting plants. Although primary and secondary recycling schemes are well established and widely applied, it is concluded that many of the PSW tertiary and quaternary treatment schemes appear to be robust and worthy of additional investigation.

© 2009 Elsevier Ltd. All rights reserved.

Contents

1. Introduction	2626
2. Re-using, sorting and primary recycling	2627
2.1. Benefits of re-using and major sorting techniques	2627
2.2. Primary recycling of PSW	2628
3. Mechanical recycling	2628
3.1. Overview	2628
3.2. Existing plants and technologies applied in mechanical recycling.	2629

Abbreviations: ABS, acrylonitrile butadiene styrene; API, alliance for the polyurethane industry; ASR, automotive shredder residues; BFBs, bubbling fluidised beds; BHET, bis-(2-hydroxyethylene-terephthalate); BTX, benzene, toluene and xylene; CAPE, carboxylated polyethylene; CCGT, combined cycle gas turbine; DEFRA, department of environment and rural affairs (UK); DMSO, dimethylsulfoxide; DMT, dimethyltryptamine; ELTs, end-of-life tyres; FRs, flame-retardants; GCC, gulf council countries; GHGs, greenhouse gases; HCV, high calorific value; HDPE, high density polyethylene; IWM, integrated waste management; LCA, Life Cycle Assessment; LDPE, low density polyethylene; LHV, lower heating value; LLDPE, linear low density polyethylene; MAPE, maleated polyethylene; MDPE, medium density polyethylene; MSW, municipal solid waste; MSWI, municipal solid waste incinerator; MSWIPs, municipal solid waste incineration plants; PA 6, nylon 6 or polyamide 6; PAH, poly aromatic hydrocarbons; PBT, polybutylene terephthalate; PE, polyethylene; PEN, polyethylene (2,6-naphthalenedicarboxylate); PET, polyethylene terephthalate; PI, polyisoprene; PMMA, polymethyl methacrylate; PP, polypropylene; PS, polystyrene; PSW, plastic solid waste; PU, polyurethane; PVC, polyvinylchloride; PVDF, polyvinylidene fluoride; R&D, research and development; RHDPE, recycled high density polyethylene; TBE, tetrabromoethane; TDM, titanium-derived mixture; VCC, viable cascade controller; XRF, X-ray fluorescent.

* Corresponding author. Tel.: +44 (0) 207 679 7868; fax: +44 (0) 207 383 2348.

E-mail address: s.al-salem@ucl.ac.uk (S.M. Al-Salem).

4.	Chemical recycling	2631
4.1.	What is chemical recycling?	2631
4.2.	Thermolysis schemes and technologies	2631
4.2.1.	Pyrolysis (thermal cracking of polymers in inert atmospheres)	2631
4.2.2.	Overview of pyrolysis plants and advanced technologies	2632
4.2.3.	Gasification	2634
4.2.4.	Common gasification technologies	2634
4.2.5.	Concluding remarks on pyrolysis and gasification	2636
4.2.6.	Hydrogenation (hydrocracking)	2637
4.3.	Other chemical recycling schemes	2637
5.	Energy recovery	2639
5.1.	Grate technology (co-incineration by direct one stage combustion process of waste)	2640
5.2.	Fluidised bed and two stage incineration	2640
5.3.	Rotary and cement kiln combustion	2640
6.	Conclusion	2641
	References	2641

1. Introduction

Ever since the first industrial scale production of synthetic polymers (plastics) took place in the 1940s, the production, consumption and waste generation rate of plastic solid waste (PSW) has increased considerably. Thus, PSW recycling has been a focus of many researchers in the past few decades. Such research is also driven by changes in regulatory and environmental issues.

Plastics are used in our daily lives in a number of applications. From greenhouses, mulches, coating and wiring, to packaging, films, covers, bags and containers. It is only reasonable to find a considerable amount of PSW in the final stream of municipal solid waste (MSW). In the European Union countries, over 250×10^6 tonnes of MSW are produced each year, with an annual growth of 3%. In 1990, each individual in the world produced an average of 250 kg of MSW generating in total 1.3×10^9 tonnes of MSW (Beede and Bloom, 1995). Ten years later, this amount almost doubled levelling at 2.3×10^9 tonnes. In US, PSW found in MSW has increased from 11% in 2002 (USEPA, 2002) to 12.1% in 2007 (USEPA, 2008). Fig. 1 illustrates the different sectors of the UK and US MSW fractions.

Thermoplastics contribute to the total plastic consumption by roughly 80%, and are used for typical plastics applications such as packaging but also in non-plastics applications such as textile fibres and coatings (Dewil et al., 2006). While plastics are found in all major MSW categories, containers and packaging plastics (bags, sacks, and wraps, other packaging, other containers, and soft drink, milk, and water containers) represent the highest tonnage (USEPA, 2002; USEPA, 2008). In durable goods, plastics are found in appliances, furniture, casings of lead-acid batteries, and other products. In the UK, recent studies show that PSW make up 7% of the final waste stream (Parfitt, 2002). Packaging accounts for 37.2% of all plastics consumed in Europe and 35% worldwide (Clark and Hardy, 2004).

Increasing cost and decreasing space of landfills are forcing considerations of alternative options for PSW disposal (Zia et al., 2007). Years of research, study and testing have resulted in a number of treatment, recycling and recovery methods for PSW that can be economically and environmentally viable (Howard, 2002). The plastic industry has successfully identified workable technologies for recovering treating, and recycling of waste from discarded products. In 2002, 388,000 tonnes of polyethylene (PE) were used to produce various parts of textiles, of which 378,000 tonnes were made from PE discarded articles (Gobi, 2002). The plastic industry is committed to meeting the current needs of today without compromising the needs of tomorrow. In the UK, 95% of PSW arising from process scrap ($\approx 250,000$ tonnes) has been recycled in 2007

(EA, 2008). PSW from commercial grade resins have been successfully recycled from a number of end-products, including: automobile parts, appliances, textiles, mulches, greenhouses and films. PSW treatment and recycling processes could be allocated to four major categories (Mastellone, 1999), re-extrusion (primary), mechanical (secondary), chemical (tertiary) and energy recovery (quaternary). Each method provides a unique set of advantages that make it particularly beneficial for specific locations, applications or requirements. Mechanical recycling (i.e. secondary or material recycling) involves physical treatment, whilst chemical recycling and treatment (i.e. tertiary encompassing feedstock recycling) produces feedstock chemicals for the chemical industry. Energy recovery involves complete or partial oxidation of the material (Troitsch, 1990), producing heat, power and/or gaseous fuels, oils and chars besides by-products that must be disposed of, such as ash.

The continued development of recycling and recovery technologies, investment in infrastructure, the establishment of viable markets and participation by industry, government and consumers are all considered priorities of the highest order (Scheirs, 1998). A Life Cycle Assessment (LCA) approach to MSW technologies will assist in identifying environmental impacts associated with the alternatives in a 'cradle to grave' fashion identifying the most sustainable options. 90% of plastics used today are synthesized using non-renewable fossil resources. It is essential to integrate waste management (IWM) schemes in the production cycle of plastics and treatment schemes of PSW. Whilst recycling is considered a sustainable practice, implying an integrated waste management (IWM) scheme provides a more sustainable developed use of energy and supplies (Fig. 2). LCA schemes aid in the selection, application of suitable techniques, technologies and management programs to achieve specific waste management objectives and goals. IWM target is to control the waste generation from processes to meet the needs of a society at minimal environmental impact and at an efficient resource usage by activating the potentials of waste prevention, re-use and recycling. The IWM cycle can be grouped into six categories, namely: (i) waste generation, (ii) waste handling, sorting and processing at the source, (iii) collection, (iv) separation and processing, (v) transfer station handling and waste transport, (vi) disposal. The functional groups are paramount, since they enable us to develop and define a framework for evaluating impacts of proposed changes in solid waste functions (Al-Jayyousi, 2001).

Due to the high thermal resistance of plastics (resulting from the addition of additives and other stabilizers whilst processing), the rapid market changes and introduction of the open loop recycling concept (manufacturing products from a number of products of less quality), energy recovery is limited and might be considered

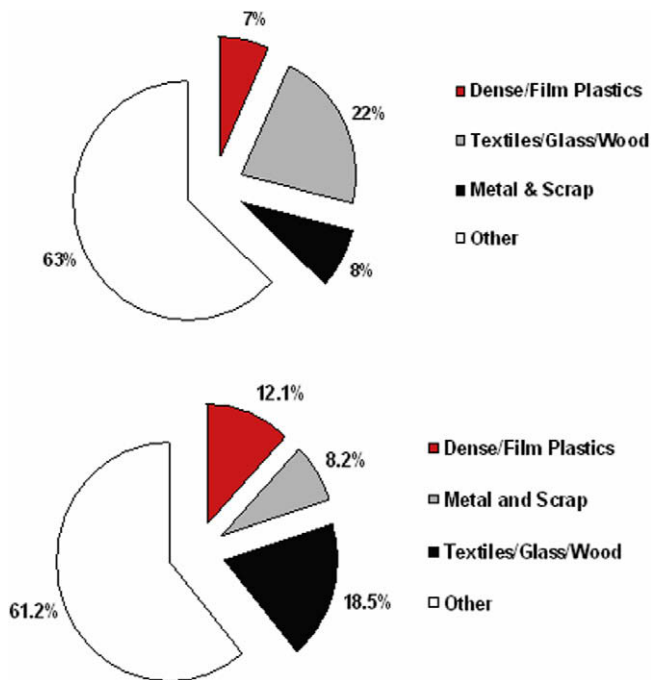

Fig. 1. Dense and film plastic fraction in MSW in the UK (top) and the US (bottom). Source: Parfitt (2002) and USEPA (2008).

in the developmental stages, especially in the case of PSW (DeGaspari, 1999). In all recycling processes (plastic, metal, paper recycling, etc.), technical and economic feasibility and overall commercial viability of advanced recycling methods must be considered in each step of the recycling chain (Frisch, 1999). Collection, processing, and marketing are each critical to the success of chemical recycling and energy recovery. Today, with few exceptions, these technologies remain developmental and have not yet proven to be sustainable in a competitive market. Nevertheless, they remain of considerable interest for their longer term potential. The aim of this review is to focus on the various recycling methods of PSW, i.e. mechanical, chemical and energy recovery, in response to the current waste generation rates and production technologies.

2. Re-using, sorting and primary recycling

2.1. Benefits of re-using and major sorting techniques

Plastics are used in a number of applications on a daily basis. Yet some plastic items end up in the waste stream after a single use only (single-life or cycle) or a short time after purchase, e.g. food packaging. Re-using plastic is preferable to recycling as it uses less energy and fewer resources. In recent years, multi-trip plastics have become a more popular choice leading to PSW reduction in the MSW final stream. In the UK, recyclable and returnable plastic crates used in transport and other purposes, have quadrupled from 1992 (8.5 million tonnes) to 2002 (35.8 million tonnes) (JCR, 2006). Re-using plastics has a number of advantages, characterised by (i) conservation of fossil fuels since plastic production uses 4–8% of global oil production, i.e. 4% as feedstock and 4% during conversion (Perdon, 2004; JCR, 2006); (ii) reduction of energy and MSW, and (iii) reduction of carbon-dioxide (CO₂), nitrogen-oxides (NO_x) and sulphur-dioxide (SO₂) emissions.

A number of techniques have been developed in order to separate and sort PSW (MOEA, 2001; EPIC, 2003). In the recycling industry, sorting and identification must be attempted within a short time to positively affect a recycler's finances. Both fast and

accurate identification of the primary plastic contained in a particular item, followed by some type of manual or automated sorting are essential. In the case of plastic bottle sorting, automated techniques do exist but are not always applicable due mainly to a difference in shape and size, or the existence of paint and coating which delays the analysis technique, etc. Another way of sorting (common in Asian recycling lines) is density sorting. Density sorting methods are not particularly helpful, because most plastics are very close in density ($\rho_{\text{HDPE}} = 0.941$, $\rho_{\text{MDPE}} = 0.926\text{--}0.940$, $\rho_{\text{LDPE}} = 0.915\text{--}0.925$, $\rho_{\text{LLDPE}} = 0.91\text{--}0.94$, $\rho_{\text{PP}} = 0.96$ g/cc). In the case of rigid PSW resulting from electronic parts, a heavy medium separation is usually applied (Kang and Schoenung, 2005). This can be done by adding a modifier to water or by using tetrabromoethane (TBE). However, this is a costly process and can lead to contamination of the recovered plastic (Veit et al., 2002; Kang and Schoenung, 2005). To enhance the effectiveness of density separation, hydrocyclones are commonly used. Hydrocyclones, which use centrifugal force, enhance material wettability. Some of the factors affecting liquid separation of a given material are its wettability, its variation in density (from porosity, fillers, pigments, etc.), shape factors of size-reduced particles, and its level of liberation from other materials. Even surface air bubbles, which can attach to plastics as the result of poor wetting or surface contamination, can cause an individual flake of material to float in a solution less dense than that of bulk material (APC, 1999).

A practical way of PSW sorting is by triboelectric separation, which can distinguish between two resins by simply rubbing them against each other. A triboelectric separator sorts materials on the basis of a surface charge transfer phenomenon. When materials are rubbed against each other, one material becomes positively charged, and the other becomes negatively charged or remains neutral. Particles are mixed and contact one another in a rotating drum to allow charging. Materials with a particle size of approximately 2–4 mm were the highest in both purity and recovery in the triboelectric process (Xiao et al., 1999).

PSW can also be sorted by a speed accelerator technique, developed by Result Technology AG (Switzerland). This technique uses a high-speed accelerator to delaminate shredded waste, and the delaminated material is separated by air classification, sieves, and electrostatics (Kang and Schoenung, 2005). Using X-ray fluorescent (XRF) spectroscopy, different types of flame-retardants (FRs) can be identified. On this basis, MBA Polymers, Inc. has developed a technology that can separate pure resin with FRs (Toloken, 1998; APC, 2003). The same company has also announced a joint venture with European Metal Recycling Limited (EMR), to establish a plastic recovering plant from shredded PSW. The plant will employ state of the art technologies that will result in a 60,000 tonnes/year commissioning in the year 2009.

No matter how efficient the recycling scheme is, sorting is the most important step in the recycling loop. One of the main issues that recyclers face is the removal of the paint on plastics. Properties of recycled plastics can be compromised because of stress concentration created by these coating materials (Kang and Schoenung, 2005). Grinding could be used to remove coatings, e.g. chrome from plated plastics can be removed by simple grinding, sometimes assisted with cryogenic methods to enhance the liberation process and to prevent the plating materials from being embedded in the plastic granules. These cryogenic methods provide good liberation, but the actual separation of plastic particles from the paint is problematic (Biddle, 1999). Another way of paint and coating removal is abrasion, best applied on whole parts of significant size. Solvent stripping is also used by recyclers, which involves the dipping of the coated plastic into a solvent, liberating coatings from the plastic. This method is applicable for compact disc coating removal (Biddle, 1999; Kang and Schoenung, 2005).

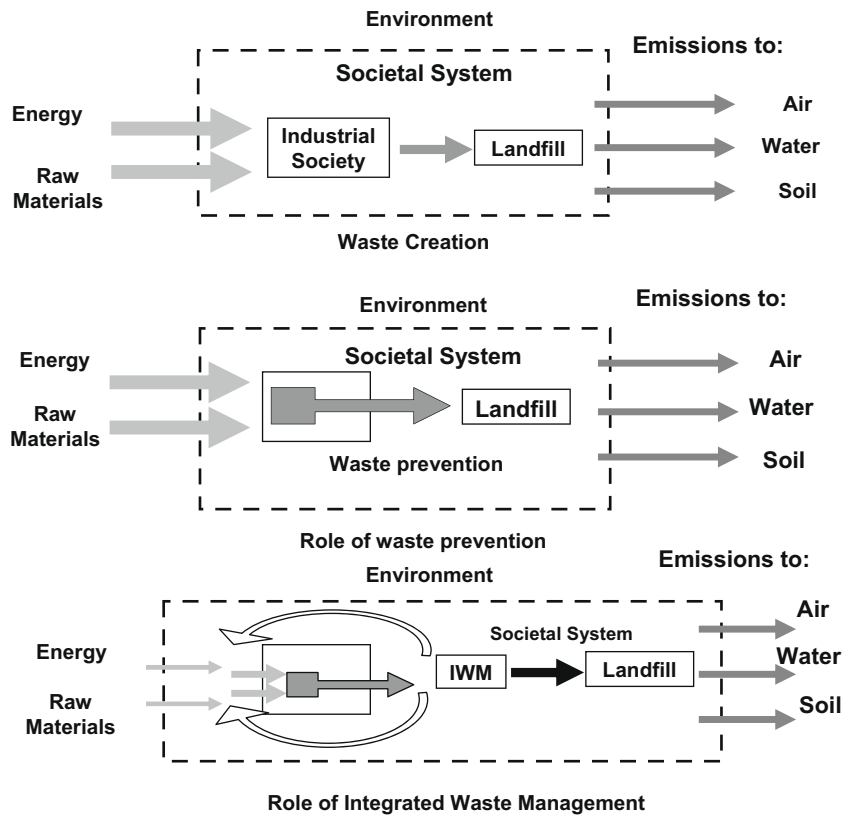

Fig. 2. Respective roles of waste prevention and integrated waste management. In Life Cycle Assessment (LCA) studies, a 'system' is defined (with boundaries indicated by broken lines). Energy and raw materials from the 'environment' are used in the system. Emissions, including solid waste, leave the system and enter the environment. Waste prevention includes the role of cleaner production, innovative services, sustainable consumption and prevention by design. Source: Kirkby et al. (2004).

The high temperature aqueous-based paint removal method relies on the hydrolysis of many coatings in hot water, thus liberating the coating from the plastic. Olefin based plastics can be handled with this technique due to the fact that this type of plastics can not be degraded under these conditions (Plastic Technology, 1994). Nevertheless, none of these techniques are completely satisfactory and they require that processing conditions be carefully controlled. Furthermore, degradation (mainly photo-oxidative) during these processes decreases the resale value of these recycle products.

2.2. Primary recycling of PSW

Primary recycling, better known as re-extrusion, is the re-introduction of scrap, industrial or single-polymer plastic edges and parts to the extrusion cycle in order to produce products of the similar material. This process utilizes scrap plastics that have similar features to the original products (Al-Salem, 2009a). Primary recycling is only feasible with semi-clean scrap, therefore making it an unpopular choice with recyclers. A valid example of primary recycling is the injection moulding of out of specification LDPE crates (Barlow, 2008). Crates that do not meet the specifications are palletised and reintroduced into the recycling loop or the final stages of the manufacturing.

Currently, most of the PSW being recycled is of process scrap from industry recycled via primary recycling techniques. In the UK, process scrap represents 250,000 tonnes of the plastic waste and approximately 95% of it is primary recycled (Parfitt, 2002). Primary recycling can also involve the re-extrusion of post-consumer plastics. Generally, households are the main source of such waste stream. However, recycling household waste represents a number

of challenges, namely the need of selective and segregated collection. Kerbside systems are required to collect relatively small quantities of mixed PSW from a large number of sources. This poses a resource drain and involves significant operating costs in many countries, especially considering the current market situation. Taking into account current market prices for virgin resins, a 0.45\$ is the return on average from every converted kg of polyolefin (EEC, 2009).

3. Mechanical recycling

3.1. Overview

Mechanical recycling, also known as secondary recycling, is the process of recovering plastic solid waste (PSW) for the re-use in manufacturing plastic products via mechanical means (Mastellone, 1999). It was promoted and commercialized all over the world back in the 1970s. Mechanical recycling of PSW can only be performed on single-polymer plastic, e.g. PE, PP, PS, etc. The more complex and contaminated the waste, the more difficult it is to recycle it mechanically. Separation, washing and preparation of PSW are all essential to produce high quality, clear, clean and homogeneous end-products. One of the main issues that face mechanical recyclers is the degradation and heterogeneity of PSW. Since chemical reactions that constitute polymer formation (i.e. polymer addition, polymerization and polycondensation) are all reversible in theory, energy or heat supply can cause photo-oxidation and/or mechanical stresses which occur as a consequence. Length or branching of polymer chains can also occur from the formation of oxidised compounds and/or harsh natural weathering condi-

tions (Mastellone, 1999; Basfar and Idriss Ali, 2006; Al-Salem, 2009b). Due to the previously stated reasons, it is very important to have a customer ready to purchase the product to achieve a sensible economical and environmental practice. Nevertheless, mechanical recycling opens an economic and viable route for PSW recovery, especially for the case of foams and rigid plastics (Zia et al., 2007).

A number of products found in our daily lives come from mechanical recycling processes, such as grocery bags, pipes, gutters, window and door profiles, shutters and blinds, etc. The quality is the main issue when dealing with mechanically recycled products. The industrial PSW generated in manufacturing, processing, and distribution of plastic products is well suited for the use as a raw material for mechanical recycling due to the clear separation of different types of resins, the low level of dirt and impurities present, and their availability in large quantities.

Mechanical recycling of PSW has also become an important issue in R&D, where numerous researchers have devoted their efforts to. Recent literature published shows a great interest in utilizing polyolefins that end up in the PSW stream. Table 1 summarizes recent literature in direct relation to PSW mechanical recycling, utilizing reclaimed and scrap in the studied schemes on bench and pilot scales.

3.2. Existing plants and technologies applied in mechanical recycling

Recycling PSW via mechanical means involves a number of treatments and preparation steps to be considered. Being a costly and an energy intense process, mechanical recyclers try to reduce these steps and working hours as much as possible. Generally, the first step in mechanical recycling involves size reduction of the plastic to a more suitable form (pellets, powder or flakes). This is usually achieved by milling, grinding or shredding (Zia et al., 2007). The most general scheme was described by Aznar et al. (2006) and is illustrated in Fig. 3. The steps involved are usually the following (Aznar et al., 2006; SubsTech, 2006):

- *Cutting/shredding*: Large plastic parts are cut by shear or saw for further processing into chopped small flakes.
- *Contaminant separation*: Paper, dust and other forms of impurities are separated from plastic usually in a cyclone.
- *Floating*: Different types of plastic flakes are separated in a floating tank according to their density.

- *Milling*: Separate, single-polymer plastics are milled together. This step is usually taken as a first step with many recyclers around the world.
- *Washing and drying*: This step refers to the pre-washing stage (beginning of the washing line). The actual plastic washing process occurs afterwards if further treatment is required. Both washing stages are executed with water. Chemical washing is also employed in certain cases (mainly for glue removal from plastic), where caustic soda and surfactants are used.
- *Agglutination*: The product is gathered and collected either to be stored and sold later on after the addition of pigments and additives, or sent for further processing.
- *Extrusion*: The plastic is extruded to strands and then pelletized to produce a single-polymer plastic.
- *Quenching*: Involves water-cooling the plastic by water to be granulated and sold as a final product.

Other single-polymer PSW go through different schemes. Many foams (namely polyurethane, PU) are powdered and grinded to a particle size less than 0.2 mm using two-roll milling, cryogenic grinders or precision knife cutters. Another process used in mechanical recycling is re-bonding, in which recycled foam flakes originating from flexible slab stock foam production waste are usually blown from storage silos into a mixer that consists of a fixed drum with rotating blades or agitators, where the foam flakes are sprayed with an adhesive mixture (Zia et al., 2007). Fig. 4 shows a schematic illustration of the re-bonding process. One of the main advantages of this process is the ability to obtain a clean product with new properties, i.e. higher density and lower hardness.

In the case of PU, 10% binder is added to the 90% scrap. Waste is shredded and mixed with binder (dyes can also be added) and the mixture is then compressed. PU recycle granules are used as filler in polyester moulding compounds and give added toughness to the material. This process yields a variety of products such as carpet underlay and athletic mats from recovered pieces of flexible foams. The re-bond process incorporates both a surprising amount of flexibility and a wide variability in the mechanical properties of the final product. PVC represents an interesting case too, in terms of mechanical recycling. With the health issues related to it, Recovinyl® Co. (UK) deals with post-consumer PVC to reproduce two grades via mechanical recycling. Due to its structure and composition, PVC can easily be mechanically recycled in order to obtain

Table 1

Summary of mechanical recycling studies in direct relation to utilizing scrap and reclaimed materials (namely blended with single virgin polymers).

Reference	Main single-polymer plastics used	Comments
Kowalska et al. (2002)	PP (Malen P F-401) Waste LDPE Waste PVC Reclaimed LDPE films Suspension PVC	<ul style="list-style-type: none"> • Thermoplastics were mixed and extruded with fillers (waste rubber granulate, whiting, cellulose fibres and wood flour) to obtain an optimum blend composition • The blend contained <50 wt% of secondary LDPE, >50 wt% of comminute rubber scrap and <0.1 wt% of blowing agent • 3–4 l/h of water permutation was achieved with the blend making it a satisfactory mixture
Strapasson et al. (2005)	PP/LDPE blends (0/100, 25/75, 50/50, 75/25 and 100/0 wt/wt%) via injection moulding	<ul style="list-style-type: none"> • Thermoplastics were mixed and extruded with fillers (waste rubber granulate, whiting, cellulose fibres and wood flour) to obtain an optimum blend composition
Lei et al. (2007)	RHDPE	<ul style="list-style-type: none"> • Composites based on RHDPE and natural fibres, made through melt blending and compression moulding were studied, so were the effects of fibres and coupling agent (type/concentration) on the composite properties • The use of MAPE, CAPE and TDM improved the compatibility between the fibre and RHDPE, and mechanical properties of the resultant composites compared well with those of virgin HDPE composites
Meran et al. (2008)	LDPE, HDPE and PP	<ul style="list-style-type: none"> • The tensile strength relation was monitored in PP since the loss of mechanical and physical properties did not exceed 50% in the films studied
Brachet et al. (2008)	PP	<ul style="list-style-type: none"> • Modification of mechanical properties of recycled PP from post-consumer containers with the addition of stabilizers, elastomer (EOR) and CaCO₃ were studied • Results showed limited changes with the addition of elastomer and CaCO₃ on the mechanical properties of the recycled PP

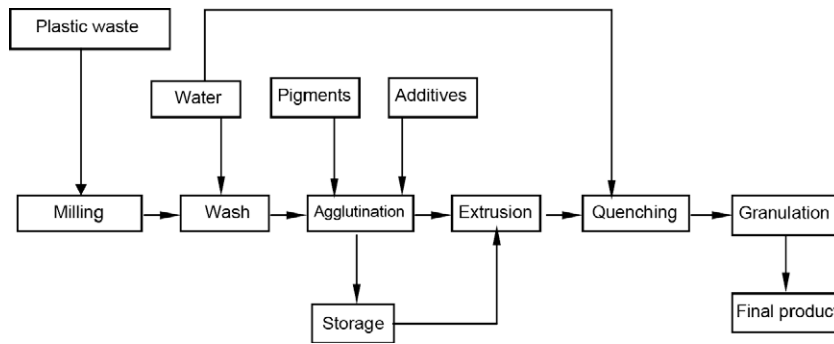

Fig. 3. Mechanical recycling steps as described by Aznar et al. (2006).

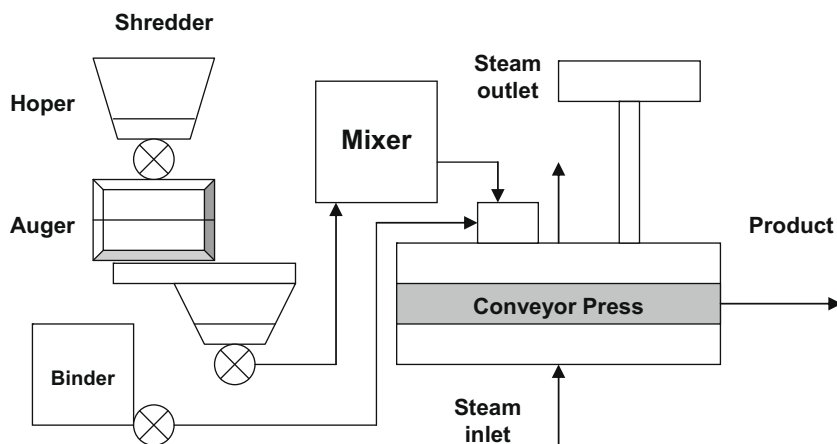

Fig. 4. Schematic of flexible foam re-bonding, adapted from Zia et al. (2007).

good quality recycling material. Careful and proper sorting is of crucial importance for the optimal recycling of PVC. After an initial visual check, the collected PVC materials are shredded into pieces of $\pm 10\text{--}15$ cm. The metals and non-ferrous metals are mechanically eliminated afterwards (Recoviny, 2008). The company classifies the post-consumer plastics into rigid and flexible material. Rigid PVC recycled material is mainly used as an inner reinforcement layer in pipes and profiles production, garden furniture or rigid films manufacture. Flexible PVC waste is recycled into powder and is used as filler in the production of floor coverings of various kinds. Other applications are traffic cones, fences, flexible hoses and tubes, footwear, bags, clothing, etc.

A valid example of utilizing PSW is the recycling of PET. About three-quarter of reclaimed PET in the UK and USA is used to manufacture fibres for carpets, apparel and bottles. Two approaches have been widely promoted, mechanical recycling and methanolysis (chemical recycling). Once the PET has been collected and sorted, it represents a feedstock for reclamation processing lines. Reclamation involves washing the materials (mainly bottles) and conditioning the plastics to be processed as semi-virgin resin or masterbatch. In doing so, a clear grade of PET can be produced of high quality to compete with the virgin polymer. This technique is practiced widely in the EU and USA. In Tokyo (Japan), a council for PET bottle recycling has been established since 1993 to promote mechanical recycling of PET bottles in the municipalities of Tokyo (Council PET, 2005). PET bottles obtained by household sorting are collected, compressed and packed by municipalities for transportation to recycling plants operated by recycling industries. At the recycling plant, the waste is selected to remove impurities and the remaining PET bottles are then shredded, cleaned, foreign bodies and non-resins separated, and the remainder turned into flakes and pellets

(granules made of flakes thermally processed by granulator) for recycling. The recycled materials are then sent to textile and sheet-making plants, where they are again molten to produce textile and sheet products by resin moulding techniques well established for PET and other plastics conversion (Council PET, 2005). These techniques could be summarized as follows:

- *Extrusion moulding*: the resin or PSW flakes are molten and extruded through a mould by single or twin screws to form a moulded product. Products from this process include pipes, sheets, film and wire covering.
- *Injection moulding*: heated molten resin is injected into a mould to solidify and form the product desired. Products made this way range from washbowls, buckets and plastic models to larger products such as bumpers and pallets.
- *Blow moulding*: a parison (hollow plastic melt) obtained by extrusion or injection moulding is clamped in a mould, and inflated with air to make bottles for all kinds of uses, such as shampoo bottles. PET bottles are made by means of stretch blow moulding so as to make them less likely to rupture.
- *Vacuum moulding*: a heat-softened sheet is sandwiched in a mould, and the space between the sheet and mould sealed and evacuated to form products such as cups and trays.
- *Inflation moulding*: extrusion moulding where a molten resin is inflated into a cylinder to form a film. This method is used to make products such as shopping bags.

Another major company that deals with PSW is Nexcycle Plastics Inc. (NPI, Canada), which markets a number of recycled products made from scrap polyolefins (NPI, 2009). NPI deals with LDPE, LLDPE, MDPE, HDPE and PP. The scrap that is being dealt with is

transformed mechanically to bales, rolls, regrinded PSW, and chunks. The company also deals with a variety of coloured scrap, including clear, white, black, mixed and printed PSW. Alternatively, many companies deal with black and/or clear scrap for mechanical recycling processing lines, saving by that cost of sorting. This is the case of Metals and Recycling Co. (MRC, Kuwait); which covers almost exclusively the GCC, far and south-eastern Asian markets. The company processes various types of scrap plastic such as PP, PE, PVC, PPC, ABS, etc. The plant's output of PE and PP is mainly delivered as clean and uniform pellets (extruded 3 × 3 mm granules), whereas other scrap materials are processed as flakes (MRC, 2009).

4. Chemical recycling

4.1. What is chemical recycling?

Chemical (tertiary) recycling is a term used to refer to advanced technology processes which convert plastic materials into smaller molecules, usually liquids or gases, which are suitable for use as a feedstock for the production of new petrochemicals and plastics (Mastellone, 1999). The term chemical is used, due to the fact that an alteration is bound to occur to the chemical structure of the polymer. Products of chemical recycling have proven to be useful as fuel. The technology behind its success is the depolymerization processes that can result in a very profitable and sustainable industrial scheme, providing a high product yield and minimum waste. Under the category of chemical recycling advanced process (similar to those employed in the petrochemical industry) appear e.g. pyrolysis, gasification, liquid–gas hydrogenation, viscosity breaking, steam or catalytic cracking and the use of PSW as a reducing agent in blast furnaces.

Recently, much attention has been paid to chemical recycling (mainly non-catalytic thermal cracking (thermolysis), catalytic cracking and steam degradation) as a method of producing various fuel fractions from PSW. By their nature, a number of polymers are advantageous for such treatment. Polyethylene terephthalate (PET) and certain polyamides (nylon 6 (PA 6) and nylon 66) can be efficiently depolymerised. In particular, polyethylene (PE) has been targeted as a potential feedstock for fuel (gasoline) producing technologies. Al-Salem et al. (2009a) studied the thermal cracking behaviour of HDPE. It was reported that PE thermally cracks into gases, liquids, waxes, aromatics and char via five primary and two secondary reactions to form five lumped products as illustrated below.

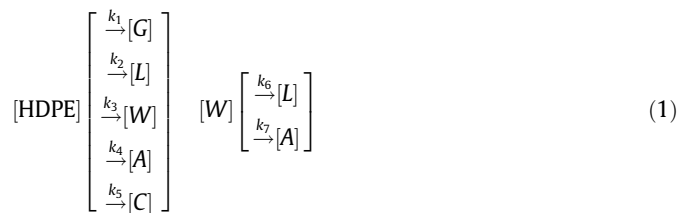

with HDPE, G, L, W, A and C standing for high density polyethylene, gases, liquids, waxes, aromatics and char fractions, respectively.

Martin-Gullon et al. (2001) studied the pyrolysis and combustion of PET. They reported that PET followed a pseudomechanism model considering the two parts of the reaction, i.e. pyrolysis and combustion. The formed chars (C_1 and C_2) will follow a third reaction to form gases, neglecting ash residue formed. Below is the reported PET cracking scheme reported.

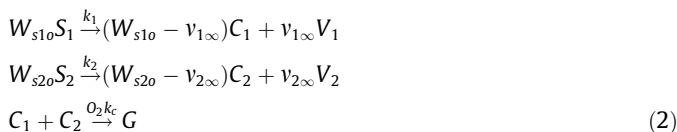

with S_i denoting the fresh part i ($i = 1, 2$) which form the original material, and C_i and V_i the char and volatiles form from the thermal cracking reaction, respectively. W_{s10} and $v_{i\infty}$ indicate the initial mass of the non reacted part of (S_i) at time zero, and the maximum volatile yield evolved from S_i , when the reaction is fully completed (at time infinity). C_1 and C_2 refer to the char formed from both steps of the mechanism.

There is also a growing interest in developing value added products such as synthetic lubricants via PE thermal degradation. The development of value added recycling technologies is highly desirable as it would increase the economic incentive to recycle polymers (Horvat, 1996). Several methods for chemical recycling are presently in use, such as direct chemical treatment involving gasification, smelting by blast furnace (Asanuma and Ariyama, 2004) or coke oven (Kato et al., 2004), and degradation by liquefaction (Steiner et al., 2002). Condensation polymers such as polyethylene terephthalate (PET) and nylon undergo degradation to produce monomer units, i.e. feedstock or monomer recycling (Yoshioka et al., 2004), while vinyl polymers such as polyolefins produce a mixture containing numerous components for use as a fuel. Various degradation methods for obtaining petrochemicals are presently under investigation, and conditions suitable for pyrolysis and gasification are being researched extensively (Aguado et al., 2007). Catalytic cracking and reforming facilitate the selective degradation of waste plastics. The use of solid catalysts such as silica-alumina, ZSM-5, zeolites, and mesoporous materials for these purposes has been reported. These materials effectively convert polyolefins into liquid fuel, giving lighter fractions as compared to thermal cracking.

The main advantage of chemical recycling is the possibility of treating heterogeneous and contaminated polymers with limited use of pre-treatment. If a recycler is considering a recycling scheme with 40% target or more, one should deal with materials that are very expensive to separate and treat. Thus, chemical recycling becomes a viable solution (Scheirs, 1998). Petrochemical plants are much greater in size (6–10 times) than plastic manufacturing plants. It is essential to utilize petrochemical plants in supplementing their usual feedstock by using PSW derived feedstock.

4.2. Thermolysis schemes and technologies

4.2.1. Pyrolysis (thermal cracking of polymers in inert atmospheres)

Thermolysis is the treatment of PSW in the presence of heat under controlled temperatures without catalysts. Thermolysis processes can be divided into advanced thermo-chemical or pyrolysis (thermal cracking in an inert atmosphere), gasification (in the sub-stoichiometric presence of air usually leading to CO and CO₂ production) and hydrogenation (hydrocracking) (Ahrenfeldt, 2007). Fig. 5 shows different thermolysis schemes, current main technologies and their main obtained products, as described by Mastellone (1999).

Thermal degradation processes allow obtaining a number of constituting molecules, combustible gases and/or energy, with the reduction of landfilling as an added advantage (Mastral et al., 2007). The pyrolysis process is an advanced conversion technology that has the ability to produce a clean, high calorific value gas from a wide variety of waste and biomass streams. The hydrocarbon content of the waste is converted into a gas, which is suitable for utilisation in either gas engines, with associated electricity generation, or in boiler applications without the need for flue gas treatment. This process is capable of treating many different solid hydrocarbon based wastes whilst producing a clean fuel gas with a high calorific value. This gas will typically have a calorific value of 22–30 MJ/m³ depending on the waste material being processed. The lower calorific value is associated with biomass waste, the

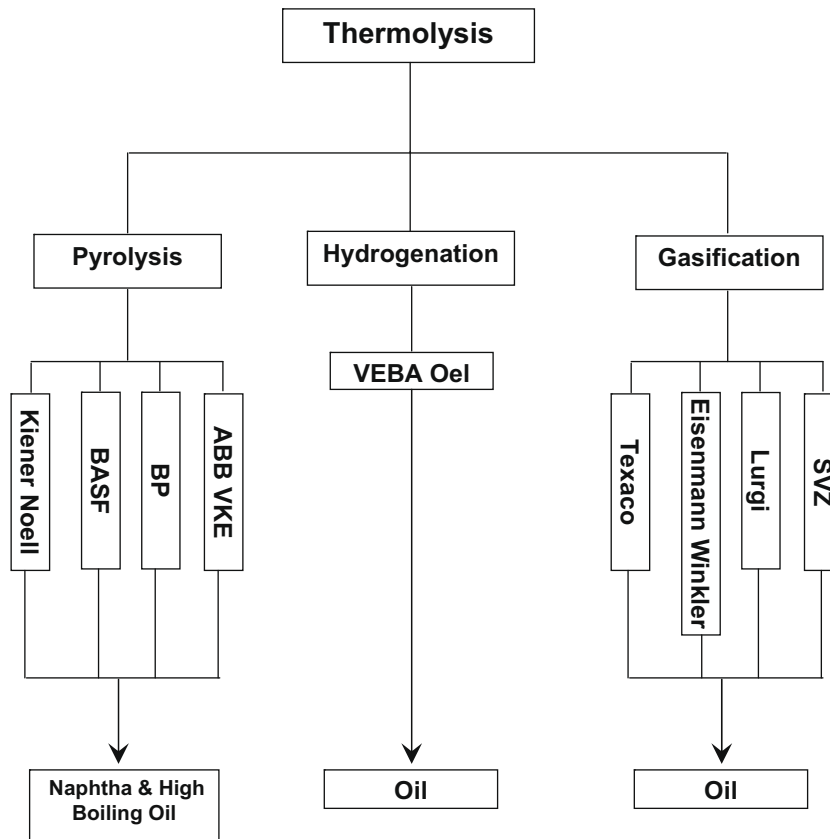

Fig. 5. Different thermolysis schemes with reference to the main technologies. Source: Mastellone (1999).

higher calorific value being associated with other wastes such as sewage sludge. Gases can be produced with higher calorific values when the waste contains significant quantities of synthetic materials such as rubber and plastics. Solid char is also produced from the process, which contains both carbon and the mineral content of the original feed material. The char can either be further processed on-site to release the energy content of the carbon, or utilized offsite in other thermal processes.

Pyrolysis provides a number of other advantages, such as (i) operational advantages, (ii) environmental advantages and (iii) financial benefits. Operational advantages could be described by the utilisation of residual output of char used as a fuel or as a feedstock for other petrochemical processes. An additional operational benefit is that pyrolysis requires no flue gas clean up as flue gas produced is mostly treated prior to utilisation. Environmentally, pyrolysis provides an alternative solution to landfilling and reduces greenhouse gas (GHGs) and CO₂ emissions. Financially, pyrolysis produces a high calorific value fuel that could be easily marketed and used in gas engines to produce electricity and heat. Several obstacles and disadvantages do exist for pyrolysis, mainly the handling of char produced (Ciliz et al., 2004) and treatment of the final fuel produced if specific products are desired. In addition, there is not a sufficient understanding of the underlying reaction pathways, which has prevented a quantitative prediction of the full product distribution.

Pyrolysis has been investigated as a viable route of recycling by a number of researchers for the case of PSW treatment (Smolders and Baeyens, 2004), or other waste including biomass (Ray et al., 2004; Van de Velden et al., 2008) and rubbers (Wu et al., 1997; Yang et al., 2004; Meng et al., 2006). Surveying the literature reveals a number of studies on polymers and PSW pyrolysis, summarized in Table 2.

4.2.2. Overview of pyrolysis plants and advanced technologies

An engineering approach to improve the overall waste incineration efficiency is to separate pyrolysis from actual combustion and burnout processes of the waste (Malkow, 2004). In industrial scale schemes, external separation requires pyrolysis reactors whilst firing products (e.g. char, waxes, etc.). One of the main technologies incorporated by a number of plants in Austria, Germany, Korea, Italy and Switzerland, is the PYROPLEQ[®] process. This technology (dominant in the period between 1978 and 1996) is based on pyrolysis at 450–500 °C in an externally heated rotary drum and gas combustion at 1200 °C. Typical feed to the process is PSW (post-consumer mixtures), although the process was proven successful for other MSW streams.

A different process which has proven to be successful for PSW, rich in PVC, is the Akzo process (Netherlands) (Tukker et al., 1999). With a capacity of 30 kg/h, this fast pyrolysis process is based on a circulating fluidised bed system (two reactors) with subsequent combustion. Input to the process is shredded mixed waste including a high percentage of PVC waste. The main outputs consist of HCl, CO, H₂, CH₄ and, depending on the feedstock composition, other hydrocarbons and fly ash. The ConTherm[®] technology treats MSW and automotive shredder residues (ASR) as well as up to 50% PSW at 500–550 °C in 100 kt/year rotary kilns supplied by TECHNIP and combusts the gas directly in a pulverised coal (PC)-fired boiler (Malkow, 2004). Residues from the process are screened and sorted to recover materials, mainly metals. The NRC process is another successful pyrolysis scheme. This process is based on the pyrolysis with subsequent metal extraction technology. The aim is to produce purified calcium chloride instead of HCl. The input to the process is PVC waste (cables, flooring, profiles, etc.). No other PSW type is fed to the processing, which results in calcium chloride, coke, organic condensate (for use as fuels) and heavy

Table 2

Summary of pyrolysis and inert atmosphere chemical treatment studies on virgin/waste plastics in bench and pilot scales.

Reference	Summary
Kaminsky et al. (1995)	A pyrolysis study in a fluidized bed which showed very good heat and material transfer. The configuration used allowed shorter residence times at moderate operating temperatures
McCaffrey et al. (1996)	Investigation of the degradation of PE and PS mixtures in co-pyrolysis processes
Bockhorn et al. (1998)	Step wise pyrolysis process for PVC, PE and PS treatment
Wong and Broadbelt (2001)	The interactions of different polymers during pyrolysis using a combination of experiments and mechanistic modelling to develop a quantitative understanding of the synergistic effects present during co-processing were studied
Mastellone et al. (2002)	Preliminary series of experiments to investigate the polymer-to-particles interactions inside a pyrolyser and effects of main operating variables on the yield and composition of products of the fluidized pyrolysis of a recycled PE grade. In the range below 650 °C, the amount of BTX and other aromatics was just appreciable
Horvat and Ng (2005)	Two-step novel pyrolysis of wasted PE articles. PE is heated in the first step, under N ₂ atmosphere, to a range of 400–450 °C to produce PE oil, and then developed the fundamental aspects of the oil was hydrogenated at 30–90 °C to produce a diesel type liquid fuel
Nishino et al. (2004,2005,2008)	Selective degradation of polyolefins (LDPE, HDPE and PP) to petrochemicals using Ga-ZSM-5 has been reported.

metals for metal recycling, as products. PKA pyrolysis is another type of pyrolysis process technology, described previously by PKA (2002) and Malkow (2004). The technology comprises a modular pyrolysis and gasification concept at high temperatures. The process starts with a pre-processing step involving separation, screening and shredding of different kind of wastes such as MSW, ASR, ELTs, industrial and plastic waste as well as contaminated soil. The pyrolysis takes place at 500–550 °C for about 45–60 min in an externally heated rotary kiln. The yield is a de-dusted and homogenised CO/H₂ rich fuel gas. Char containing minerals and metals are conditioned by separating ferrous and non-ferrous metals, reduced in moisture to <10% and ground to <2 mm before being used as a fuel, a sorbent (i.e. activated carbon) or a raw material in brick production (Malkow, 2004). The PyroMelt process (developed by ML Entsorgungs und Energieanlagen GmbH) combines pyrolysis and slagging combustion yielding an elution-resistant, recyclable granulated slag (Juniper, 2005). The feed to the process consists of MSW, hazardous waste, ASR and post-consumer plastic waste. Pyrolysis takes place prior to the combustion process and the resulting gas is subjected to multiple scrubbing steps using pyrolysis oil. This process cools the gas from the range of 500 to

600 °C down to 120 to 150 °C. However, the char is cooled to 50 °C and jointly combusted with a slurry composed of dust and heavy pyrolysis oils in a melt furnace.

One of the most important pyrolysis processes is the BP polymer cracking process (Tukker et al., 1999). After a series of pilot trails (between 1994 and 1998), a plant was established in Scotland with a capacity of 25,000 tonnes/year. Fig. 6 shows a schematic of the BP polymer cracking process. Size reduction is required for the feed, which is then fed to a heated fluidized bed reactor (operating at 500 °C) in the absence of air. Input specifications for the process are shown in Table 3 below. Plastics crack thermally under these conditions to hydrocarbons which vaporise and leave the bed with the fluidising gas. PSW decomposition leads to HCl formation (from PVC), which is neutralized by bringing the hot gas into contact with a solid lime absorbent (ECVM, 1997). Eight-five percent by weight of the plastic that enters the process is passed on as hydrocarbon liquid, and the remaining 15% is gas at ambient temperature. The gas has a high content of monomers (ethylene and propylene) and other useful hydrocarbons with only some 15% being methane (Brophy et al., 1997). Total solids produced are typically up to 0.2 kg/kg of total solids feed.

**Fig. 6.** BP polymer cracking process as described by Hoyle and Karsa (1997) and Tukker et al. (1999).

Table 3
BP polymer cracking process input specifications. Source: Tukker et al. (1999).

Material	Unit	Normal	Maximum limit
Polyolefins	wt%	80	Minimum 70
PS	wt%	15	Maximum 30
PET	wt%	3	Maximum 5
PVC	wt%	2	Maximum 4
Total plastic content	wt%	92	Minimum 90
Ash	wt%	2	Maximum 5
Moisture	wt%	0.5	Maximum 1
Metal pieces	wt%	–	Maximum 1
Size	mm	1–20	
Fines sub-250 micron	wt%	–	Maximum 1
Bulk density	kg m ⁻³	400	300

One of the main pyrolysis technologies ever commissioned is the BASF process (Fig. 7). The process started with a pilot plant capacity of 15,000 tonnes/year (Ludwigshafen, Germany) in 1994. As it is the case with many recycling thermo-chemical schemes, the process starts with a pre-treatment step. Mixed PSW is grinded, and separated from metals and agglomerated materials (Heyde and Kremer, 1999). The conversion of the PSW into valuable petrochemicals takes place in a multi-stage melting and reduction process. The hydrogen chloride separated out in this process is absorbed and processed in the hydrochloric acid production plant. Hence, the major part of the chlorine present in the input (e.g. from PVC) is converted into saleable HCl. Minor amounts come available as NaCl or CaCl₂ effluent (Heyde and Kremer, 1999).

An alternative technology that has proven to be very successful for PSW treatment (especially for the case of PVC cable waste) is the NKT process (Fig. 8). The process is based on an initial pre-treatment step that involves separating light plastics (PP, PE, etc.) and other materials, e.g. wood, sand, iron, steel, brass, copper and other metallic pollutants. The PSW waste is then fed to a reactor at a low pressure (2–3 bars) and a moderate temperature (375 °C). The process emits neither dioxins, chlorine, metals nor plasticizers. Also, there are no liquid waste streams in the process since all streams are recycled within the system. There is a small volume of carbon-dioxide gas formed by the reaction between lime/limestone and hydrogen chloride. Mixed PVC building waste containing metals, sand, soil, PE, PP, wood and rubber waste have been successfully treated. Other pyrolysis processes (smaller scale) are also available and are in operation. Table 4 summarizes these pyrolysis processes and their current status.

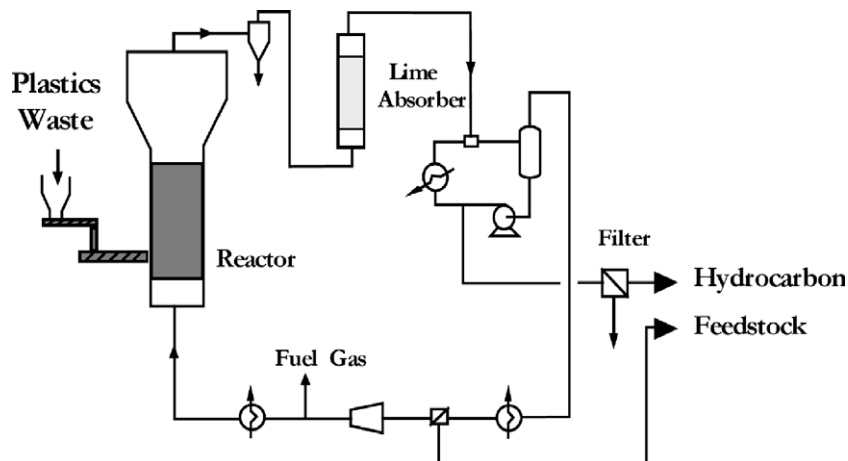
The most applied within this group of processes, is the Noell process, for its ability to convert 25% of the feedstock to oil (Tukker et al., 1999). The process operates a rotary kiln reactor for an input density of 250 kg m⁻³. It is also worth mentioning that the pyrolysis process is rapidly gaining importance for polyolefin feedstock and PU foams. Zia et al. (2007) reported the PU pyrolysis resulting from automobile seats and other end-products. A two zone pyrolysis reactor was also suggested for PU char processing.

4.2.3. Gasification

Declining landfill space and high incineration cost of MSW encourage research and development in thermolysis technologies, which gasification fall into, producing fuels or combustible gases

from waste (CPPIA, 2007). Air in this process is used as a gasification agent, which demonstrates a number of advantages. The main advantage of using air instead of O₂ alone is to simplify the process and reduce the cost. But a disadvantage is the presence of (inert) N₂ in air which causes a reduction in the calorific value of resulting fuels due to the dilution effect on fuel gases. Hence, steam is introduced in a stoichiometric ratio to reduce the N₂ presence. Several types of gasification processes have already been developed and reported. Their practical performance data, however, have not necessarily been satisfactory for universal application. A significant amount of char is always produced in gasification which needs to be further processed and/or burnt. Other gasification schemes (mainly in pilot scale) use a great deal of expensive pure oxygen, whilst others necessitate considerable amounts of expensive materials such as coke and limestone, and deposit much sludge from which metals cannot be separated. An ideal gasification process for PSW should produce a high calorific value gas, completely combusted char, produce an easy metal product to separate ash from and should not require any additional installations for air/water pollution abatement.

Early gasification attempts of MSWs, namely plastics, have been reported since the 1970s (Buekens, 1978; Hasegawa et al., 1974). The gasification into high calorific value fuel gas obtained from PSW was demonstrated in research stages and results were reported and published in literature for PVC (Borgianni et al., 2002), PP (Xiao et al., 2007) and PET (Matsunami et al., 1999). Also a need for utilizing as much waste as possible to treat in co-gasification is something that captured the attention of many researchers. The need for alternative fuels has lead for the co-gasification of PSW with other types of waste, mainly biomass. Pinto et al. (2002, 2003) studied the fluidized bed co-gasification of PE, pine and coal and biomass mixed with PE. Slapak et al. (2000) designed a process for steam gasification of PVC in a bubbling fluidized bed. Xiao et al. (2009) co-gasified five typical kinds of organic components (wood, paper, kitchen garbage, plastic (namely PE), and textile) and three representative types of simulated MSW in a fluidized-bed (400–800 °C). It was determined that plastic should be gasified at temperatures more than 500 °C to reach a lower heating value (LHV) of 10,000 kJ/N.

4.2.4. Common gasification technologies

One of the most common technologies is the Waste Gas Technology UK Limited (WGT) process (Fig. 9). Different types of wastes (PSW, MSW, sludges, ELTs) are dried and mechanically pre-treated, sorting out incombustibles and granulated to optimum sized particles and fed into a cylindrical reactor for gasification at 700–900 °C to yield a HCV gas (WGT, 2002). Upon discharge and subsequent separation of gas and char, the latter may be utilized via combustion in a boiler to raise steam while the gas is quenched and cleaned of contaminants prior to its use in a gas engine or turbine and possibly CCGT applications. A demonstration plant of 500 kg/h sewage sludge capacity was installed by the licensee OSC Process Engineering Ltd. in the autumn of 1998 for Welsh Water at Nash Water Works in South Wales mainly to fire the dryer. A 110 kg/h unit was furthermore installed in France in 2000.

The Texaco gasification process is by the far the most common and well known technology. First pilot scale experiments (10 tonnes/day) were carried out in the USA (Weissman, 1997). In the liquefaction step the plastic waste is mildly thermally cracked (depolymerization) into synthetic heavy oil and some condensable and non-condensable gas fractions. Oil and condensed gas produced are injected to the entrained gasifier (Croezen and Sas, 1997). The gasification is carried out with oxygen and steam at a temperature of 1200–1500 °C. After a number of cleaning processes (amongst others, HCl and HF removal), a clean and dry synthesis gas is produced, consisting predominantly of CO and H₂, with smaller amounts of CH₄, CO₂, H₂O and some inert gases

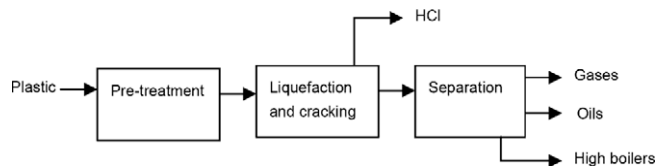

Fig. 7. BASF pyrolysis process. Source: Heyde and Kremer (1999).

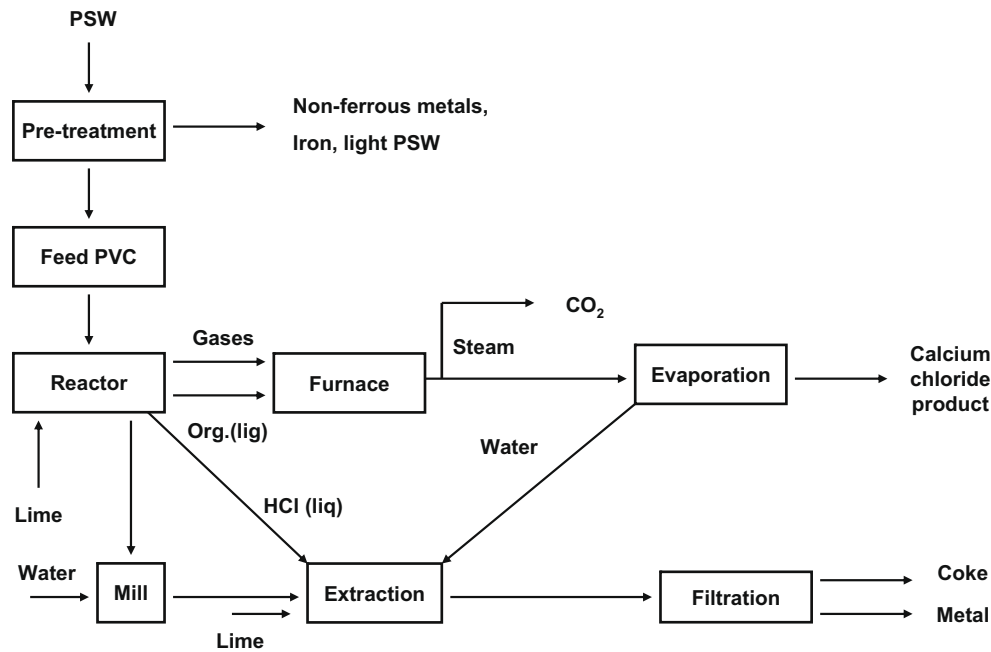

Fig. 8. NKT process diagram. Source: Tukker et al. (1999).

Table 4

Summary of other pyrolysis processes, their operating conditions and current status.

Technology name	Operating conditions	Notes	Reference
KEU process	$T_{op} = 350\text{--}550\text{ }^{\circ}\text{C}$ Input: PVC waste (pelletised) Output: slag, dust and energy	Pyrolysis in a vertical reactor Char produced is burned in a rotary drum incinerator	Buhl (1999)
Wayene	$T_{op} = 900\text{ }^{\circ}\text{C}$ Input: PE, PP, PS Output: 75–89% medium oil, 15–20% light oil	High temperature pyrolysis Proven capacity: 50 tonnes/day	Tukker et al. (1999)
Toshiba	Input: PSW with 20% chlorine content (powder) Output: 90% oil $P_{op} \geq 10\text{ atm}$ $T_{op} = 650\text{--}750\text{ }^{\circ}\text{C}$	Reports show technology in research stage	Tukker et al. (1999)
Berliner process	Input: PSW Output: 5% cokes, 2% metals, 3% inert solids, 38% BTX and light fraction, 3% medium fraction and gas	Pilot scale Proven capacity: 20,000 tonnes/year	Tukker et al. (1999)
Noell	$T_{op} = 650\text{--}750\text{ }^{\circ}\text{C}$ Input: PSW, 65% linear, 20% cyclic and 15% PVC Output: slag, dust and energy	Industrial scale and capacity proven	Tukker et al. (1999)

(Tukker et al., 1999). Table 5 summarizes the products from the input criteria and process.

In the case of PSW severely contaminated with other waste products, (including contaminated wood, waste water purification sludge, waste-derived fuel, paper fractions, etc.) SVZ process constitutes the optimum solution. The input is fed into a reactor (kiln), together with lignite (in the form of briquettes) and waste oil. Oxygen and steam are used as gasification media, and are supplied in counter flow with the input materials (Tukker et al., 1999). This process synthesizes gas (a mixture of hydrogen and CO), liquid hydrocarbons, and effluent. Liquid hydrocarbons are further processed by oil pressure. The gas is used mainly for methanol production and around 20% is used for electricity production. One of the main advantages of this process is its tolerance for various input parameters. Tukker et al. (1999) stated a number of acceptance criteria for the SVZ process, summarized below:

- Particle size: >20–80 mm.
- Chlorine content: 2% as default, though higher concentrations are tolerable.
- Ash content: up to 10% or more.

As a producer of chlorine and vinylchloride, Akzo Nobel started a process for mixed PSW gasification. The process consists of two separate circulating fluid bed (CFB) reactors at atmospheric pressure. The first is a gasification reactor in which waste (usually rich with PVC) is converted at 700–900 °C into product gas (fuel and HCl gas) and tars. The second unit is a combustion reactor that burns the residual tar to provide heat for the gasification process. Both reactors are of the riser type with a very short residence time. If the input contains a lot of PE and PP, the output will contain a significant amount of propylene and ethylene (Tukker et al., 1999).

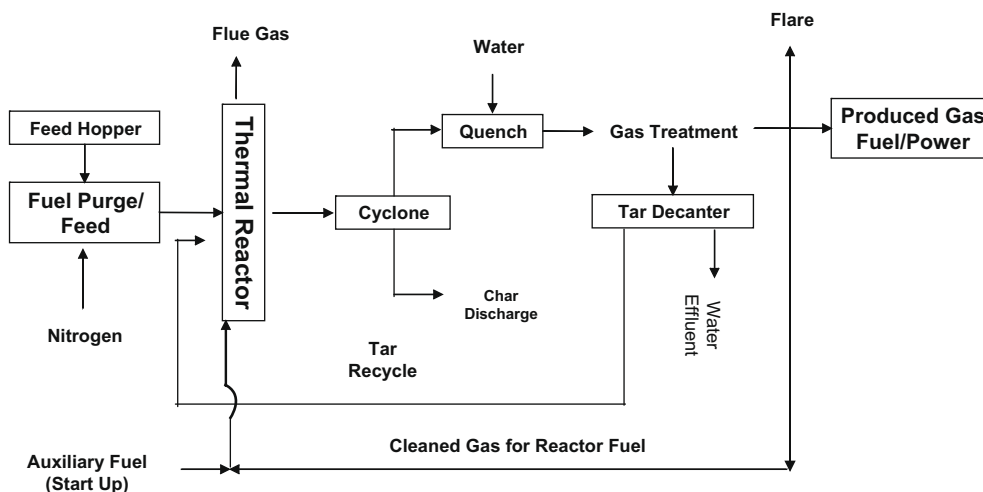

Fig. 9. WGT process schematic. Source: WGT (2002).

Table 5

Input criteria and expected output for the Texaco gasification process. Source: Tukker et al. (1999).

<i>Input criteria: 10% tolerance to inorganics and 10% tolerance to PVC</i>	
Material texture	Dry to the touch, not sticky
Physical description	Shredded or chipped with size less than 10 cm
Physical fines content	Less than 1% under 250 μm
Bulk density	>100 g/l
Form at delivery	Agglomerated
PSW content	>90 wt%
Free metals	<1 wt%
PVC content	<10 wt%
Ash content	<6 wt%
Residual moisture	<5 wt%
Paper content	<10 wt%
<i>Expected products</i>	
Synthesis gas	350,000 Nm^3 /day (predominantly H_2/CO) out of 150 tonnes of PSW/day
Pure sulphur	–
Saleable NH_4Cl	–
Vitrified slag	–
Fines	High quality, equivalent to fly ash

4.2.5. Concluding remarks on pyrolysis and gasification

Both pyrolysis and gasification produce three different phases: a solid phase (char, 5–25 wt%), a liquid phase (tars, 10–45 wt%) and a gas phase (Aznar et al., 2006; Zia et al., 2007). First products yielded are usually in the range of C_{20} – C_{50} . These products are cracked in the gas phase to obtain lighter hydrocarbons, as ethene and propene, which are unstable at high temperatures and react to form aromatic compounds as benzene or toluene. If the residence time is long, coke, methane and hydrogen form (Westerhout et al., 1998). In thermo-chemical treatment of polyolefins (mainly PE and PP), products obtained mainly depend on cracking reactions in the gas phase. Long residence times of volatiles in reactors and high temperatures decrease tar production but increase char formation (Cozzani et al., 1997). The main disadvantage of plastic pyrolysis and gasification is that it is necessary to control the chloride content in the feedstock and the risk of bad fluidization because of particle agglomeration (Kaminsky et al., 1995). It is believed that increasing temperatures above 500 °C and prolonging the gas residence time, result in a reduction in tar content of the gas product from both pyrolysis and gasification of PSW, ASR, MSW and even mixtures of coal, biomass and PSW (Stiles and

Kandiyoti, 1989; Pinto et al., 2003; Zolezzi et al., 2004; Miscolczi et al., 2004; Ciliz et al., 2004). In fact, at temperatures above 800 °C larger paraffines and olefins produced from decomposition of plastics are cracked into H_2 , CO , CO_2 , CH_4 and lighter hydrocarbons (Ponzio et al., 2006). As a result of methyl-group abstraction from aromatics and decomposition of paraffines, C_2H_4 and C_2H_2 are typically reported to increase with temperature (Ledesma et al., 2000). The abstraction methyl-groups and hydroxyl groups from aromatic structures imply that the aromatic fraction does increase with temperature even though the total amount of tar decreases. H_2 -abstraction from light hydrocarbons and crosslinking reactions may also produce PAH.

At elevated temperatures (around 850 °C), PSW pyrolysis yields almost exclusively aromatics, C_2H_4 and CH_4 (Mastral et al., 2002, 2003). The increase of the aromatic fraction with increasing gas phase temperature is also reported for PSW and MSW (Day et al., 1999; Brage et al., 2000). To crack polyaromatic hydrocarbons, very high temperatures (>1200 °C) and long residence times are required (Milne et al., 1998). Typical cracking products (H_2 , C_2H_4 and C_2H_2) increase with elevated operating temperatures (Zolezzi et al., 2004). In PSW gasification, endothermic gasification reactions involving steam and CO_2 (Franco et al., 2003; Marquez-Montesinos et al., 2002) and high heating rates create a char which is more reactive and easier to deal with (Zanzi et al., 1996, 2002). As a result of these reactions, a high gasification temperature has been reported to increase the H_2 concentration (Lv et al., 2004), gas yield (Pinto et al., 2002) and sometimes LHV (Narvaez et al., 1996) for a wide range of gasification configurations and oxidizing media. Concluding, based on the previous findings, both pyrolysis and gasification could be further utilized in industry in a more engineered and designed end-product fashion. Up till now, most pyrolysis and gasification processes applied on an industrial scale lack a designed end-product manner. Both processes could be improved by more appropriate scale-up and a detailed analysis of the products produced. Many of the products yielded by pyrolysis and gasification are well marketed. But a fact remains that an even larger market is now emerging for residual solids, to be utilized as carbon black or activated carbon.

Although large industrial scale units do exist for both pyrolysis and gasification, a fact remains that most of them could perform more effectively targeting certain products depending on feedstock, market performance and demand. All of such issues could be solved by end-product unit design. Thermal decomposition schemes on the end-product (employing lumped product yield) are an essential step to develop and validate. Advances in that area

will aid in the improvement of pyrolysis and gasification reactors (Gebauer, 1995; Al-Salem et al., 2009a,b).

4.2.6. Hydrogenation (hydrocracking)

Hydrogenation by definition means the addition of hydrogen (H_2) by chemical reaction through unit operation (March, 1992). The main technology applied in PSW recycling via hydrogenation technology is the Veba process. Based upon the coal liquefaction technology, Veba Oel AG[®] converted coal by this process into naphtha and gas oil. The current PSW treatment technology employs a depolymerization section, where the agglomerated plastic waste is kept between 350 and 400 °C to effect depolymerization and dechlorination (in the case of PVC rich waste). The overhead of this product is partially condensed (Tukker et al., 1999). The condensate, containing 18% of the chlorine input, is fed into a hydrotr- eater. The HCl is eliminated with the formation water. The resulting Cl-free condensate and gas are mixed with the depoly- merisate for treatment in the VCC section. The main outputs of the process could be summarized as follows:

- HCl.
- Syncrude from the VCC section (chlorine free).
- Hydrogenated solid residue.
- Off gas.

The input for the depolymerization section was described by Sas (1994), and summarized below:

- Particle size < 1.0 cm
- Bulk density $\geq 300 \text{ kg/m}^3$
- Water content < 1.0 wt%
- PVC < 4% ($\leq 2 \text{ wt\%}$ chlorine)
- Inerts < 4.5 wt% at 650 °C
- Metal content < 1.0 wt%
- Content of plastic $\geq 90.0 \text{ wt\%}$

Other reports of hydrogenation process could be accounted for. These technologies are either terminated (stopped on an industrial

scale) or in research stage. Major technologies are summarized in Table 6 below (Sas, 1994; Heyde and Kremer, 1999; Tukker et al., 1999).

4.3. Other chemical recycling schemes

Other recycling schemes employing processes of a thermal deg- radation nature are stated in this section. Most technologies (on an industrial scale) operate a reactor in the process, whether being a kiln or a rotary drum, etc. Table 7 summarizes degradative extru- sion technologies. The process employs high operating tempera- tures and influences PSW degradation via mechanical and chemical energy (Michaeli and Lackner, 1995). Degradation pro- moting additives might be employed.

Degradative extrusion provides an optimum engineering solu- tion especially on a small-industrial scale (10 kg/h). Menges and Lackner (1991) stated the advantages of degradative extrusion as (i) achieving molecular breakdown of thermoplastics and hence low viscosity polymer melts, (ii) applying a combination of mechanical and chemical recycling scheme prompts the degrada- tion process by introducing steam, gas, oxygen or catalysts, if needed. Another advantageous technology for chemical treatment is catalytic and steam cracking (Table 8). The concept for both pro- cesses is the employment of either steam or a catalyst in a unit operation.

Whilst degradative extrusion, steam and catalytic cracking are employed worldwide, thermoplastics (mainly polyolefins) are advantageous for other recovery methods that are present on both pilot and industrial schemes. These schemes fall into the category of chemical recycling, and can be subdivided into feedstock (mono- mer) recycling and recycling of chemical nature.

Recycling PSW via pure chemical routes could be summarized by the following technologies: hydrolysis, glycolysis, fractionation, hydroglycolysis, aminolysis, methanolysis and acid cleavage. Table 9 summarizes chemical recycling schemes, not stated previously and not classified within the thermo-chemical treatment category.

Table 6
Hydrogenation process (no longer in operation). Source: Tukker et al. (1999).

Technology	Operating parties	Status	Notes
RWE process	RWE-Entsorgungs AG	Project is now terminated	<i>Operation:</i> hydrogenation after depolymerization of plastic waste. PSW is mixed with oil followed by depolymerization (10 kg/h). HCl is removed after depolymerization <i>PC:</i> $T_{op} = 400\text{--}500 \text{ }^\circ\text{C}$, $P = 300\text{--}400 \text{ bar}$ <i>Output:</i> 80% oil, 10% gas and solids
Hiedrierwerke process	Hiedrierwerke Zeitz GmbH	Project is now terminated	<i>Operation:</i> PSW cracking by hydrogenation <i>Input:</i> visbreaking melt of 100% PSW <i>PC:</i> $T_{op} = 400 \text{ }^\circ\text{C}$, $P = 250 \text{ bar}$ <i>Output:</i> paraffin and oil
Freiberg process	Bergakademie Freiberg	Project is now terminated	<i>Operation:</i> PSW cracking by hydrogenation <i>Input:</i> small particles of PVC, PE and PS <i>PC:</i> $T_{op} = 400\text{--}435 \text{ }^\circ\text{C}$, $P = 28 \text{ MPa}$ <i>Output:</i> oil, gas and solids

PC: process conditions, T_{op} (°C): operating temperatures.

Table 7
Main degradative extrusion technologies employed for PSW processing.

Technology name	Operating conditions	Notes	Reference
IKV process	$T_{op} = 300\text{--}400 \text{ }^\circ\text{C}$ Input: maximum PVC content is 80%	Lab/pilot scale Twin screw extruders employed	Brandrup et al. (1996), Tukker et al. (1999)
Leuna degradative extrusion process	Cap: 400 kg/h $T_{op} = 400 \text{ }^\circ\text{C}$	Feasibility proven	Brandrup et al. (1996), Tukker et al. (1999)
Stahlwerkke Bremen	Cap: 200 kg/h Process is mainly used to lower the viscosity	Research stage	Tukker et al. (1999)

Table 8
Summary of main steam and catalytic cracking technologies employed in PSW chemical recycling.

Technology name	Process conditions	Notes	References
Fuji process	$T_{op} = 400\text{ }^{\circ}\text{C}$, $T_{ip} = 250\text{ }^{\circ}\text{C}$ Capacity (pilot): 500 tonnes/year Capacity (ind.): 5000 tonnes/year	Industrial scale Low temperature catalytic cracking Employing pyrolysis technology Zeolite catalysts are used (ZSM5) Input: polyolefin waste Output: 80% oil, 15% gas and 5% solid rest fraction	Brandrup et al. (1996), Tukker et al. (1999)
Kentucky process	$T_{op} = 400\text{--}450\text{ }^{\circ}\text{C}$, $P = 56\text{ atm}$ Input: PSW Output: 90% oil	Developed in the University of Kentucky Research stage Zeolite catalysts are used	Tukker et al. (1999)
Leuna degradative extrusion + steam cracking process	T_{op} (extrusion) = $400\text{--}500\text{ }^{\circ}\text{C}$, T_{op} (extrusion) $\geq 800\text{ }^{\circ}\text{C}$ Input: 13 wt% PSW Output: C2, C3 and C4 monomers	Description: light PSW fraction is treated with degradative extrusion and then mixed with paraffin from hydrocracking. This mixture is the input for steam cracker Project showed good results but terminated due to lack of interest	Tukker et al. (1999)
Amoco	$T_{op} = 490\text{--}580\text{ }^{\circ}\text{C}$ Input: PE, PP, PS, PSW mixed with vacuum gas oil Input quality: in solution Output: naphtha, light mineral oil	Research	Tukker et al. (1999)
Mazda	Input: shredded PSW from scrap car parts. Output: 60% (oil + kerosene)	Pilot	Tukker et al. (1999)
Nikon	$T_{op} = 200\text{--}250\text{ }^{\circ}\text{C}$ Input: PSW (10 mm in size) Output: 80% oil	Pilot Metal catalyst are employed Research	Tukker et al. (1999)
Molten Metal Technology	$T_{op} = 1400\text{ }^{\circ}\text{C}$ Input: PSW and organic waste Output: synthesis gas, HCl, slag	Nickel based catalyst are used 30% HCl has been recovered in lab scale	ECVM, 1997

PC: process conditions, T_{op} ($^{\circ}\text{C}$): operating temperatures, T_{ip} ($^{\circ}\text{C}$): input temperatures.

Table 9
Summary of chemical and monomer (feedstock) recycling schemes of a non thermo-chemical nature.

Technology name	Process conditions	Notes	References
PET hydrolysis	$T_{op} = 200\text{ }^{\circ}\text{C}$ $P = 2\text{--}5\text{ MPa}$	PET is heated with an excess of water at high temperatures	Brandrup et al. (1996), Scheirs (1998), Zia et al. (2007)
PU hydrolysis (Bayer General Motors)	–	Pilot scale	Scheirs (1998), Zia et al. (2007)
PA 6 treatment via thermolysis/hydrolysis	$T_{op} = 300\text{ }^{\circ}\text{C}$ $P = 20\text{--}100\text{ bar}$	Depolymerization (monomer) recycling with water at high temperatures	Tukker et al. (1999)
PET methanolysis	$T_{op} > 200\text{ }^{\circ}\text{C}$ $P > 2\text{ MPa}$	Metal catalysts are applied in this process Insensitive to contaminants	Mastellone (1999)
PET glycolysis	$T_{op} > 200\text{ }^{\circ}\text{C}$	Acceleration with catalyst	Tukker et al. (1999)
PMMA depolymerization	$T_{op} > 300\text{ }^{\circ}\text{C}$	Molten baths used (tin and lead) Several minutes residence time	Tukker et al. (1999), Smolders and Baeyens (2004)
Acid cleavage of PA 6	Phosphoric acid medium used	Industrial scale	Tukker et al. (1999)

Table 10 summarizes the main findings in R&D studies on chemical recycling schemes.

First of the chemical recycling schemes is hydrolysis (refers to the reaction with water) which can produce both polyols and amine intermediates (Scheirs, 1998) from post-consumer PSW (Fig. 10). The most common single-polymer plastics treated via hydrolysis are PET and PU foams. Polyols produced from hydrolysis can be used as effective fuels (Zia et al., 2007) and the intermediates can be used to produce virgin single-polymer plastics (i.e. PU). This method uses heated, oxygen free environment to break down PU and other PSW into gases, oils and solids (Zia et al., 2007). It is believed that superheated steam ($200\text{ }^{\circ}\text{C}$) converts PU foams into a two-phase liquid within around 15 min, at a volume reduction of factor of 30. The chemistry can be summarized as:

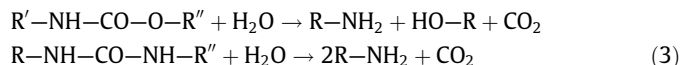

Focusing on the recovery of the polyols showed that superheated steam temperature should be around $288\text{ }^{\circ}\text{C}$, producing a polyol that can be utilized in virgin plastic production when mixed with 5% pure resins. Other hydrolysis treatments could be combined with a basic thermolysis scheme. This is demonstrated by the case of PA 6 treatment, which also follows a monomer or feedstock recycling scheme. A step description was given by Mastellone (1999), for the case of PET glycolysis. At a temperature exceeding $240\text{ }^{\circ}\text{C}$ in a catalytic bed, the addition of ethylene glycol to PET (condensation polymer produced by the reversible reaction of terephthalic acid and Ethylene glycol) the formation of bis-hydroxyethyl terephthalate

Table 10

Summary of polymers chemical recycling studies published in recent years.

Polymer/method	Main products	Notes	References
PET glycolysis	(BHET) was obtained with >60% yield by successive recrystallization	PET waste was glycolytically depolymerized using excess of ethylene glycol in the presence of sodium sulphate	Shukla et al. (2008)
PET glycolysis	BHET	BHET recovered was purified and converted to fatty amide	Shukla et al. (2009)
PET glycolysis	BHET	Ethylene glycol was used with ionic liquids as catalysts	Wang et al. (2009)
PEN glycolysis followed by aminolysis	PEN oligomer	Glycolysis of PEN was carried out in diethylene glycol	Yamaye et al. (2006)
PET hydrolysis	Disodium salt (Na ₂ -TPA) and ethylene glycol	Tributylhexadecylphosphonium bromide was used as a catalyst. A shrinking core model was developed for the reaction kinetics	López-Fonseca et al. (2009)
PBT methanolysis	DMT	Supercritical methanol was used and a kinetic model was proposed based on ester exchange	Jie et al. (2006)
PET methanolysis	DMT and ethylene glycol	Process carried out at temperature 200 °C in methanol with AIP catalyst	Kurokawa et al. (2003)
PET aminolysis	BHET	Process carried out with excess of ethanolamine	Shukla and Harad (2006)

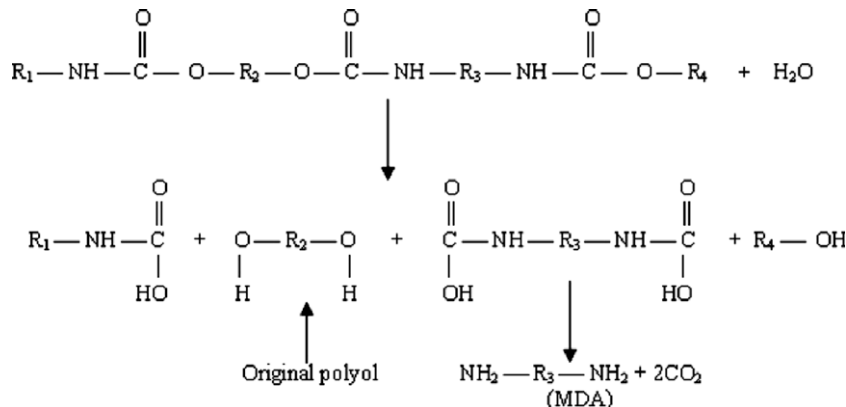
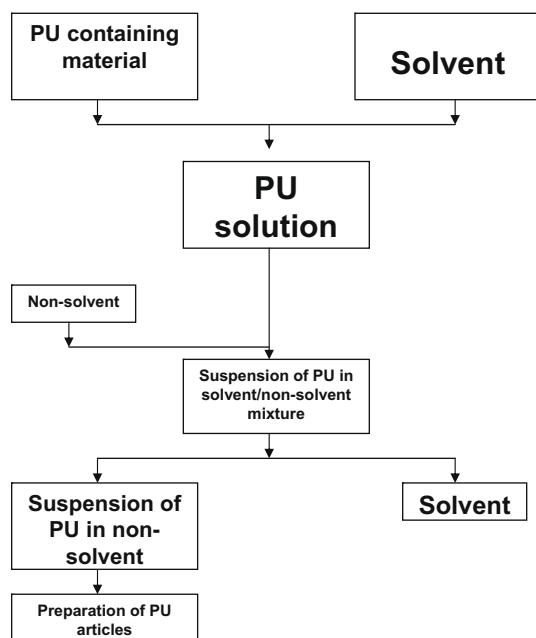
**Fig. 10.** Chemistry of hydrolysis of PU results in the formation of diamines like diphenyl methane diamine (MDA). Source: Scheirs (1998) and Zia et al. (2007).**Fig. 11.** Schematic of fractionation process of PU foam recycling. Source: Zia et al. (2007).

late will occur. After treatment with water, terephthalic acid (original monomer) will form giving us the hydrolysis step. If instead of water, methanol was used, the dimethyl ester of terephthalic acid would be formed along with ethylene glycol (methanolysis).

Another chemical treatment scheme (commonly used for PET and PU) is glycolysis, which describes a polymer's reaction with diols at temperatures above 200 °C (Zia et al., 2007). The objective of this process is to recover polyols and use the granules (6 mm) for several hours. Unlike alcoholysis (reaction with alcohol under pressure at elevated temperatures), the process is widely used for granules recovered from foam PSW (Frisch and Klemper, 2001). A different chemical process used in chemical treatment schemes is fractionation. A description was given by Zia et al. (2007) for the methods applied in PU containing materials illustrated in Fig. 11. The principle is based on combining a PU containing material with a solvent to form a solution. The solvent is usually a polar one chosen from the dimethylsulfoxide group (DMSO); finally a filtration process is conducted to remove the solution before the non-solvent is added to form a suspension.

5. Energy recovery

By definition, *Energy recovery* implies burning waste to produce energy in the form of heat, steam and electricity. This is only considered a very sensible way of waste treatment, when material recovery processes fail due to economical constraints. Plastic mate-

Table 11

Calorific value of some major plastics compared with common fuels. Source: Williams and Williams (1997) and Mastellone (1999).

Item	Calorific value (MJ kg ⁻¹)
Polyethylene	43.3–46.5
Polypropylene	46.50
Polystyrene	41.90
Kerosene	46.50
Gas oil	45.20
Heavy oil	42.50
Petroleum	42.3
Household PSW mixture	31.8

rials possess a very high calorific value (when burned); especially when considering that they are derived from crude oil. Table 11 illustrates the calorific value of a number of single-polymer plastics, compared to oil and MSW. Since the heating value of plastics is high, they make a convenient energy source. Producing water and carbon-dioxide upon combustion make them similar to other petroleum based fuels (Dirks, 1996).

In general, it is considered that incineration of PSW results in a volume reduction of 90–99%, which reduces the reliability on land-filling. In the process of energy recovery, the destruction of foams and granules resulting from PSW also destroys CFCs and other harmful blowing agents present (Zia et al., 2007). Yet again, the presence of FRs complicates the technical aspects of energy recovery receiving much of the attention nowadays.

A number of environmental concerns are associated with co-incinerating PSW, mainly emission of certain air pollutants such as CO₂, NO_x and SO_x. The combustion of PSW is also known to generate volatile organic compounds (VOCs), smoke (particulate matter), particulate-bound heavy metals, polycyclic aromatic hydrocarbons (PAHs), polychlorinated dibenzofurans (PCDFs) and dioxins. Carcinogenic substances (PAHs, nitro-PAHs, dioxins, etc.) have been identified in airborne particles from incineration or combustion of synthetic polymers such as PVC, PET, PS and PE. Capture and removal of flue gases in thermal (in general) and combustion processes (in particular) is a major issue dealt with by (i) ammonia addition to the combustion chamber, (ii) flue gas cooling, (iii) acid neutralization, (iv) activated carbon addition and/or (v) filtration (Yassin et al., 2005). Burnt gas from flames is commonly circulated in two ways in many industrial processes: (i) internally, by baffling and restricting flow of the burnt gas away from the burner, resulting in flame re-entry, (ii) externally, by diverting up to 10% of the flue gas back into the flame. In incineration processes, temperature is an essential parameter that leads to a reduction in CO and N₂O accompanied with an increase in NO_x. The addition of waste material is found to reduce N₂O but enhanced NO_x formation and this is believed to be due to the release of fuel-N from waste materials being mostly NH₃ groups. The conversion of fuel-N to NO_x varied from 4% to 6% and this is below what is usually observed in fluidised beds. This was demonstrated in a study by Boavida et al. (2003), where the conversion of fuel-S to SO₂ was almost complete during co-incineration of PSW with coal. However, the addition of waste was observed to reduce SO₂ due to the presence of greater Ca in the waste ash. Emissions of heavy metals are in the same order of magnitude in coal or coal/PSW blends, and are lower than the limits imposed by the EU directives (Boavida et al., 2003). Hence, PSW could be considered as a renewable energy source under certain constraints of feed preparations.

5.1. Grate technology (co-incineration by direct one stage combustion process of waste)

Normal municipal solid waste and similar material, including the regular plastics, can easily be accepted by MSWIs. For dedi-

cated waste streams, some elements have to be taken into account. First, if one wants to produce reusable slags, the heavy metal input into the incinerator should be limited. Furthermore, an important point is the relatively low incineration temperature of MSWIs (around 850 °C). Direct incineration can be used for many types of waste. In the USA, over 190 incinerators have exceeded the design capacity of 110 tonnes/day. Whilst Germany has the highest number of incinerators in Europe, with over 53 units exceeding the capacity of 10.7 million tonnes/year (Pollution Issue, 2007). Current technologies can recover the inherent energy value of PSW and reduce fossil fuel consumption. A series of experiments conducted by the Alliance of the Polyurethane Industry (API, US), adding flexible PU and other fractions of PSW to MSW (up to 20 wt%). This resulted in a high calorific value fuel, whilst ash generation remained constant (API, 2007).

In Europe, ISOPA supports the incineration of MSW (with high PSW content) (ISOPA, 2001). Several locations around the continent provide electrical supply local communities (up to 10% of demand) through incineration, e.g. Denmark, Sweden, Germany. In the UK, DEFRA announced that currently 15 energy from waste (EfW) plants exist in the UK with a design capacity exceeding 3 million tonnes of municipal waste (DEFRA, 2006). In Europe, an average 7% of this integral household waste consists of plastics (Tukker et al., 1999; Rand et al., 2000). Municipal solid waste incinerators (MSWIs) are usually built to deal with waste of a calorific value between 9 and 13 MJ/kg. Reference is usually made to Rittmeyer and Vehlow (1993) and Rittmeyer et al. (1994) on the co-firing of PSW (PU filled) in municipal solid waste incineration plants (MSWIPs). The TAMARA test incineration was used equipped with a co-current furnace.

5.2. Fluidised bed and two stage incineration

A detailed study by Weigand et al. (1996) shows the application of bubbling fluidised beds (BFBs) in the combustion of MSW with a high fraction of plastic in it. The coal fired BFB was a 39 MW reactor with superheated steam at 475 °C and 64 bars. When used with large fractions of PU foam, PE and PS, the coal mix resulted in a heating value of 17.6 MJ/kg. Emissions of pollutants or carbon-in-ash did not increase, except for the concentration of the ten trace elements grouped as Sn + As + Pb + Cr + Co + Cu + Mn + Ni + V + Sn which increased by a factor of three to four (0.06–0.09 → 0.22–0.32 mg/m³) which is mainly due to the presence of Sn (tin) used as a catalyst in polymerization (Zia et al., 2007). A two stage incineration was successful in the study conducted by Rogaume et al. (1999) aiming at optimising combustion conditions that result in minimal NO and CO emissions by combusting PU foams from automobile car seats.

5.3. Rotary and cement kiln combustion

A Finnish study (Zevenhoven et al., 2003) considered the behaviour of nitrogen from polymers and plastics in waste-derived fuels during rotary kiln combustion. It was found that the emissions of NO + NO₂ during rotary kiln combustion in an entrained gas quartz tube reactor (at 750–950 °C, in 7% O₂/93% N₂) depended strongly on the amount of char produced from high-nitrogen fuels (PU foam, nylon, RDF, MSW, urea/formaldehyde glue, sewage sludge) and the nitrogen content of the fuels. At nitrogen content of 6.6 wt%, less than 10% of the PU nitrogen was emitted as NO + NO₂.

One of the main technologies used in incineration via rotary kilns is the BSL technology. The rotary kiln is able to process solid, fluid, and gaseous waste streams into useful feedstocks and energy. If necessary, natural gas or liquid energy carriers can be added in order to reach the necessary high temperatures. The waste is incinerated in the rotary kiln and a post-combustion chamber, directly

after the rotary kiln, at temperatures of 900–1200 °C. The flue gas from the post-combustion is cooled from 1200 °C to the range of 230–300 °C. The process can deal with a mixture of high-chlorinated wastes (solvents, chlorinated tars, plastics). The accepted particle size for the incineration process is 10 × 10 × 10 cm. When larger parts are offered, a shredder is needed. No information about accepted moisture content, amount of dirt, etc. has been obtained.

Other industrial schemes utilize cement kilns as incinerators. The energy costs of cement kilns can be up to 25% of the turnover, and the financial benefits of using waste as a fuel are obvious. Many cement kilns in the UK, Belgium, the Netherlands, Switzerland and other countries have therefore started to use pre-treated waste streams as a fuel. Cement kilns produce a clinker by sintering alkalic raw materials such as lime (CaCO₃), clay (SiO₂ and Al₂O₃) and gypsum (CaSO₄) in a kiln at a very high temperature (1450 °C in the solid fraction). The kiln can, in fact, be seen as a rotary kiln with a much longer length (200 m). Furthermore, the solid materials flow in the opposite direction to the incineration gases. The length of the kiln results in a long residence time of incineration gases at high temperatures: 4–6 s at 1800 °C and 15–20 s at 1200 °C (Tukker et al., 1999). Two processes are dominant in this application, i.e. a dry and wet process. In the dry process the raw materials are introduced in dry form into the kiln. In the wet process, these materials are introduced in the form of slurry. The type of process used depends, amongst others things, on the source of the kiln's raw materials. A clear disadvantage of the wet process is that it needs much more energy than the dry process (5000 MJ/tonnes against 3600 MJ/tonnes clinker, respectively), since no water has to be evaporated in the dry process.

6. Conclusion

The various recycling technologies of PSW presented in this paper, have contributed greatly to the eco-image of waste management and particularly to PSW recycling, treatment and recovery. Re-using and decreasing single-life polymeric materials will certainly benefit the current situation. By initiating the loop of recycling in a processing line, one can integrate it with the process scrap re-extrusion occurring at different scales with different thermoplastics. Certain disadvantages appear when mechanical recycling is chosen as a route of recycling. The types of the polymer based plastic, its condition and suitability as well as the intense energy consumption involved are all major issues concerning PSW. For the practical application of any of these recycling methods to be successful, it should be stressed that by-products resulting from the various mechanical treatments should have similar properties of commercial grade plastics with respect to their type and monomer origin. Tertiary treatment of waste plastic articles is by far a more sustainable solution. Not only it recovers valuable petrochemicals as feedstock, providing in the process a recycling route, it also produces energy in the form of heat, steam, etc.

Plastic solid waste (PSW) is derived from oil and has a recoverable energy, in some cases comparable to other energy sources. Direct incineration via one or two stage combustion technologies can certainly reduce the volume of PSW as well as the dependence on fossil fuels, which as a result can lead to a better conservation of natural resources and integrated waste management schemes. It is very important to consider recycling and energy recovery methods in plastic manufacturing and converting facilities. Many tertiary and quaternary technologies appear to be robust to warrant further research and development in the near future.

References

Aguado, J., Serrano, D.P., Miguel, G.S., Escola, J.M., Rodriguez, J.M., 2007. Catalytic activity of zeolitic and mesostructured catalysts in the cracking

- of pure and waste polyolefins. *Journal of Analytical and Applied Pyrolysis* 78 (1), 153–161.
- Ahrenfeldt, J., 2007. Characterization of biomass producer gas as fuel for stationary gas engines in combined heat and power production. Ph.D. Thesis, Department of Chemical Engineering, Technical University of Denmark, Lyngby, Denmark.
- Al-Jayyousi, O., 2001. A methodology for evaluating environmental impact of solid waste disposal sites: case study from Jordan. *Arabian Journal of Science and Engineering* 26 (2C), 81–88.
- Al-Salem, S.M., 2009a. Establishing an integrated databank for plastic manufacturers and converters in Kuwait. *Waste Management* 29 (1), 479–484.
- Al-Salem, S.M., 2009b. Influence of natural and accelerated weathering on various formulations of linear low density polyethylene (LLDPE) films. *Materials and Design* 30 (5), 1729–1736.
- Al-Salem, S.M., Lettieri, P., Baeyens, J., 2009a. Thermal pyrolysis of high density polyethylene (HDPE). In: *Proceedings of the Ninth European Gasification Conference: Clean Energy and Chemicals*, Düsseldorf, Germany, 23–25 March.
- Al-Salem, S.M., Lettieri, P., Baeyens, J., 2009b. Could end of life tyres (ELTs) be recognized as a feedstock rather than waste? Kinetics of polyisoprene (PI) thermal cracking in inert atmospheres. In: *Proceedings of the 14th European Biosolids and Organic Resources Conference, Workshop and Exhibition*, Leeds, England, UK, 9–11 November.
- American Plastics Council (APC), 1999. Development of hydrocyclones for use in plastic recycling. Technical paper.
- American Plastics Council (APC), 2003. An industry full of potential: ten facts to know about plastics from consumer electronics. Technical paper.
- Alliance for the Polyurethanes Industry (API), 2007. Available at: <http://www.polyurethane.org/recycling>.
- Asanuma, M., Ariyama, T., 2004. Recycling of waste plastics in blast furnace. *Journal of Japan Institute of Energy* 83 (4), 252–256.
- Aznar, M.P., Caballero, M.A., Sancho, J.A., Francs, E., 2006. Plastic waste elimination by co-gasification with coal and biomass in fluidized bed with air in pilot plant. *Fuel Processing Technology* 87 (5), 409–420.
- Barlow, C., 2008. Intelligent Recycling (presentation). Department of Engineering, Institute for Manufacturing, University of Cambridge.
- Basfar, A.A., Idriss Ali, K.M., 2006. Natural weathering test for films of various formulations of low density polyethylene (LDPE) and linear low density polyethylene (LLDPE). *Polymer Degradation and Stability* 91 (3), 437–443.
- Beede, D.N., Bloom, D.E., 1995. Economics of the generation and management of MSW. NBER Working Papers 5116. National Bureau of Economic Research, Inc.
- Biddle, M., 1999. An Overview of Recycling Plastics from Durable Goods: Challenges and Opportunities. *Indentiplast II*, Belgium.
- Boavida, D., Abelha, P., Gulyurtlu, I., Cabrita, I., 2003. Co-combustion of coal and non-recyclable paper and plastic waste in a fluidised bed reactor. *Fuel* 82 (15–17), 1931–1938.
- Bockhorn, H., Hornung, A., Hornung, U., 1998. Stepwise pyrolysis for raw material recovery from plastic waste. *Journal of Analytical and Applied Pyrolysis* 46 (1), 1–13.
- Borgianni, C., Filippis, P.D., Pochetti, F., Paolucci, M., 2002. Gasification process of wastes containing PVC. *Fuel* 14 (81), 1827–1833.
- Brachet, P., Høydal, L.T., Hinrichsen, E.L., Melum, F., 2008. Modification of mechanical properties of recycled polypropylene from post-consumer containers. *Waste Management* 28 (12), 2456–2464.
- Brage, C., Yu, Q., Chen, G., Sjöström, K., 2000. Tar evolution profiles obtained from gasification of biomass and coal. *Biomass and Bioenergy* 18 (1), 87–91.
- Brandrup, J., Bittner, M., Michaeli, W., Menges, G., 1996. *Recycling and Recovery of Plastics*. Hanser Publishers, Munich, Germany.
- Brophy, J.H., Hardmann, S., Wilson, D.C., 1997. Polymer cracking for feedstock recycling of mixed plastic wastes. In: Hoyle, W., Karsa, D.R. (Eds.), *Chemical Aspects of Plastics Recycling*. The Royal Society of Chemistry Information Services, Cambridge, UK.
- Buekens, A.G., 1978. Resource recovery and waste treatment in Japan. *Resource Recovery and Conservation* 3, 275–306.
- Buhl, R., 1999. Options for PVC feedstock recycling: results of the ECVI R+D project on PVC feedstock recycling processes. In: *Proceedings of PVC 99, 23–24th April*, Brighton, UK.
- Ciliz, N.K., Ekinci, E., Snape, C.E., 2004. Pyrolysis of virgin and waste polyethylene and its mixtures with waste polyethylene and polystyrene. *Waste Management* 24 (24), 173–181.
- Clark, J.H., Hardy, J.J.E., 2004. Towards sustainable chemical manufacturing: polylactic acid – a sustainable polymer. In: Azapagic, A., Perdon, S., Clift, R. (Eds.), *Sustainable Development in Practice: Case Studies for Engineers and Scientists*, first ed. Wiley, pp. 250–282.
- Council PET, 2005. The council for PET bottle recycling, PET bottle recycling inline, report on mechanical recycling of plastic solid waste. Available at: <http://www.petbottle-rec.gr.jp/english/index.html>.
- Cozzani, V., Nicolèlla, C., Rovatti, M., Tognotti, L., 1997. Influence of gas phase reactions on the product yields obtained in the pyrolysis of polyethylene. *Industrial & Engineering Chemistry Research* 36 (2), 342–348.
- China Plastics Processing Industry Association (CPPIA), 2007. Chinese plastics industry goes from strength to strength. *Plastics, Additives and Compounding* 3 (7), 30–32.
- Croezen, H., Sas, H., 1997. Evaluation of the Texaco gasification process for treatment of mixed household waste. Final Report of Phase 1 and 2, CE, Delft, Netherlands.

- Day, M., Shen, Z., Cooney, J.D., 1999. Pyrolysis of automobile shredder residues: experiments with a laboratory screw kiln reactor. *Journal of Analytical and Applied Pyrolysis* 51 (1), 181–200.
- DEFRA, 2006. Municipal Waste Management Statistics 2004/05, March.
- DeGaspari, J., 1999. *Mechanical Engineering Magazine (ASME)*, June.
- Dewil, R., Everaert, K., Baeyens, J., 2006. The European plastic waste issue: trends and toppers in its sustainable re-use. In: *Proceedings of the 17th International Congress of Chemical and Process Engineering*, 27–31 August, Prague, Czech Republic.
- Dirks, E., 1996. Energy recovery from plastic waste in waste incineration plants. In: Brandrup, J., Bittner, M., Menges, G., Michaeli, W. (eds), first ed., Hanser Verlag Publish., pp. 746–769.
- EA, 2008. UK Environment Agency. Technical Report No. 223–4598, Waste facts.
- ECVM, 1997. PVC feedstock recycling in Europe: an overview of processes and recent developments. ECVM, May.
- EEC, 2009. AR5 Recycling Plastic Waste: Recommendation Action. Oregon State University, Technical Report.
- EPIC, 2003. Environmental and Plastics Industry Council, Management of Plastics in EOL Electronics. Special News and Views Report.
- Franco, C., Pinto, F., Gulyurtlu, I., Cabrita, I., 2003. The study of reactions influencing the biomass gasification process. *Fuel* 82 (7), 835–842.
- Frisch, K.C., 1999. *Advances in Plastic Recycling*, vol. 1. Technomic Publishing, ISBN: 1-56676-737-1.
- Frisch, K.C., Klemper, D., 2001. *Advances in Plastic Recycling*, vol. 2. Technomic Publishing, ISBN: 1-56676-793-8.
- Gebauer, M., 1995. Feedstock recycling of waste plastic. *Kunststoffe Plast Europe* 85 (2), 16–23.
- Gobi, 2002. New Forecasts for Polypropylene, Polystyrene and Polyurethane, Gobi International, May 20.
- Hasegawa, M., Fukuda, X., Kunii, D., 1974. Gasification of solid waste in a fluidized with circulating sand. *Conservation & Recycling* 3 (2), 143–153.
- Heyde, M., Kremer, S., 1999. *LCA Packaging Plastics Waste*. LCA Documents Vol. 2, No. 5. EcoMed, Landsberg, Germany.
- Horvat, N., 1996. Tertiary polymer recycling: study of polyethylene thermolysis and polyethylene oil hydrogenation. Ph.D. Thesis, Chemical Engineering Department, University of Waterloo, Canada.
- Horvat, N., Ng, F.T.T., 2005. Tertiary polymer recycling: study of polyethylene thermolysis as a first step to synthetic diesel fuel. *Fuel* 78 (4), 459–470.
- Howard, G.T., 2002. Biodegradation of polyurethane: a review. *International Biodeterioration and Biodegradation* 49 (1), 245–252.
- Hoyle, W., Karsa, D.R., 1997. *Chemical Aspects of Plastics Recycling*, Royal Society of Chemistry, Cambridge, England.
- ISOPA, 2001. Best practice for recovering polyurethane rigid foam from construction and demolition waste. Position paper, May.
- JCR, 2006. Plastics recycling. Final Assessment Report, St. Catherine's College JCR, University of Oxford, UK. Available at: <http://hadriel.caths.cam.ac.uk/jcr/html/modules.php>.
- Jie, H., Ke, H., Wenjie, Q., Zibin, Z., 2006. Process analysis of depolymerization polybutylene terephthalate in supercritical methanol. *Polymer Degradation and Stability* 91 (10), 2527–2531.
- Juniper, 2005. Pyrolysis and gasification fact sheet. Juniper consultancy group report, Gloucestershire, England.
- Kaminsky, W., Schlesselmann, B., Simon, C., 1995. Olefins from polyolefins and mixed plastics by pyrolysis. *Journal of Analytical and Applied Pyrolysis* 32, 19–27.
- Kang, H., Schoenung, J.M., 2005. Electronic waste recycling: a review of U.S. infrastructure and technology options. *Resources, Conservation and Recycling* 45 (4), 368–400.
- Kato, K., Fukuda, K., Takamatsu, N., 2004. Waste plastics recycling technology using coke ovens. *Journal of Japan Institute of Energy* 83 (4), 248–251.
- Kirkby, N., Azapagic, A., Romero-Hernandez, O., 2004. Municipal solid waste management: can thermodynamics influence people's opinions about incineration. In: Azapagic, A., Perdon, S., Clift, R. (Eds.), *Sustainable Development in Practice: Case Studies for Engineers and Scientists*, first ed. Wiley (Chapter 5).
- Kowalska, E., Wielgosz, Z., Pelka, J., 2002. Use of post life waste and production waste in thermoplastic polymer compositions. *Polymers & Polymers Composites* 10 (1), 83–91.
- Kurokawa, H., Ohshima, M., Sugiyama, K., Miura, H., 2003. Methanolysis of polyethylene terephthalate (PET) in the presence of aluminium tiisopropoxide catalyst to form dimethyl terephthalate and ethylene glycol. *Polymer Degradation and Stability* 79 (3), 529–533.
- Ledesma, E.B., Kalish, M.A., Nelson, P.F., Wornat, M.J., Mackie, J.C., 2000. Formation and fate of PAH during pyrolysis of fuel-rich combustion of coal primary tar. *Fuel* 79 (14), 1801–1814.
- Lei, Y., Wu, Q., Yao, F., Xu, Y., 2007. Preparation and properties of recycled HDPE/natural fibre composites. *Composites Part A: Applied Science and Manufacturing* 38 (7), 1664–1674.
- López-Fonseca, R., González-Velasco, J.R., Gutiérrez-Ortiz, J.I., 2009. A shrinking core model for the alkaline hydrolysis of PET assisted by tributylhexadecylphosphonium bromide. *Chemical Engineering Journal* 146 (2), 287–294.
- Lv, P.M., Xiong, Z.H., Chang, J., Wu, C.Z., Chen, Y., Zhu, J.X., 2004. An experimental study of biomass air–steam gasification in a fluidized bed. *Bioresource Technology* 95 (1), 95–101.
- Malkow, T., 2004. Novel and innovative pyrolysis and gasification technologies for energy efficient and environmentally sound MSW disposal. *Waste Management* 24 (1), 53–79.
- March, J., 1992. *Advanced Organic Chemistry: Reactions, Mechanisms, and Structure*, fourth ed. John Wiley & sons, US.
- Marquez-Montesinos, F., Cordero, T., Rodriguez-Mirasol, J., Rodriguez, J.J., 2002. CO₂ and steam gasification of grapefruit skin char. *Fuel* 81 (4), 423–429.
- Martin-Gullon, I., Esperanza, M., Font, R., 2001. Kinetic model for the pyrolysis and combustion of poly-(ethylene terephthalate) (PET). *Journal of Analytical and Applied Pyrolysis* 58–59, 635–650.
- Mastellone, M.L., 1999. Thermal treatments of plastic wastes by means of fluidized bed reactors. Ph.D. Thesis, Department of Chemical Engineering, Second University of Naples, Italy.
- Mastellone, M.L., Perugini, F., Ponte, M., Arena, U., 2002. Fluidized bed pyrolysis of a recycled polyethylene. *Polymer Degradation and Stability* 76 (3), 479–487.
- Mastral, F.J., Esperanza, E., García, P., Juste, M., 2002. Pyrolysis of high-density polyethylene in a fluidised bed reactor: influence of the temperature and residence time. *Journal of Analytical and Applied Pyrolysis* 63 (1), 1–15.
- Mastral, F.J., Esperanza, E., Berruoco, C., Juste, M., Ceamanos, J., 2003. Fluidized bed thermal degradation products of HDPE in an inert atmosphere and in air–nitrogen mixtures. *Journal of Analytical and Applied Pyrolysis* 70 (1), 1–17.
- Mastral, J.F., Berruoco, C., Ceamanos, J., 2007. Theoretical prediction of product distribution of the pyrolysis of high density polyethylene. *Journal of Analytical and Applied Pyrolysis* 80 (2), 427–438.
- Matsunami, J., Yoshida, S., Yokota, O., Nezuka, M., Tsuji, M., Tamaura, Y., 1999. Gasification of waste tyre and plastic (PET) by solar thermochemical process for solar energy utilization. *Solar Energy* 65 (1), 21–23.
- McCaffrey, W.C., Brues, M.J., Cooper, D.G., Kamal, M.R., 1996. Thermolysis of polyethylene/polystyrene mixtures. *Journal of Applied Polymer Science* 60 (12), 2133–2140.
- Meng, X., Xu, C., Gao, J., 2006. Secondary cracking of C₄ hydrocarbons from heavy oil catalytic pyrolysis. *The Canadian Journal of Chemical Engineering* 84 (3), 322–327.
- Menges, G., Lackner, V., 1991. *Plastic wastes degrading extrusion to produce usable gases*, Hanser (München), Germany, ISSN: 0023-5563.
- Meran, C., Ozturk, O., Yuksel, M., 2008. Examination of the possibility of recycling and utilizing recycled polyethylene and polypropylene. *Materials & Design* 29 (3), 701–705.
- Michaeli, W., Lackner, V., 1995. Degradative extrusion as a pre-treating process for chemical recycling of plastics waste. *Die Angewandte Makromolekulare Chemie* 232 (4138), 167–285.
- Milne, T.A., Abatzoglou, N., Evans, R.J., 1998. Biomass gasification (tars): their nature, formation and maturation. NREL/TP, p. 570-25357.
- Miscolci, N., Bartha, L., Deák, G., Jóver, B., 2004. Thermal degradation of municipal solid waste for production of fuel-like hydrocarbons. *Polymer Degradation and Stability* 86 (2), 357–366.
- Minnesota Office of Environmental Assistance (MOEA), 2001. Recycling used electronics report on Minnesota's demonstration project, July.
- Metals and Recycling Company (MRC), 2009. Industrial division fact sheet. State of Kuwait. Available at: <http://www.mrckw.com>.
- Narvaez, I., Orio, A., Aznar, M.P., Corella, J., 1996. Biomass gasification with air in an atmospheric bubbling fluidized bed: effect of six operational parameters. *Industrial and Engineering Chemistry Research* 35 (1), 2110–2120.
- Nishino, J., Itoh, M., Fujiyoshi, H., Ishinomori, T., Kubota, N., 2004. Development of a feedstock recycling process for converting waste plastics to petrochemicals. *IHI Engineering Review* 37 (2), 64–70.
- Nishino, J., Itoh, M., Fujiyoshi, Y., Matsumoto, Y., Takahashi, R., Uemichi, Y., 2005. Development of a feedstock recycling process for converting waste plastics to petrochemicals. In: *Proceedings of the Third International Symposium on Feedstock Recycle of Plastics & Other Innovative Plastics Recycling Techniques*, Karlsruhe, Germany, 25–29th, pp. 325–332.
- Nishino, J., Itoh, M., Fujiyoshi, H., Uemichi, Y., 2008. Catalytic degradation of plastic waste into petrochemicals using Ga-ZSM-5. *Fuel* 87 (17–18), 3681–3686.
- Nexcycle Plastics Inc. (NPI), 2009. *Plastic Recycling, Polymers and Resins*. Available at: <http://www.npiplastic.com>.
- Parfitt, J., 2002. Analysis of household waste composition and factors driving waste increases, WRAP for strategy unit. Government Cabinet Office, London, UK.
- Perdon, S., 2004. Sustainable development in practice: case studies for engineers and scientists. In: Azapagic, A., Perdon, S., Clift, R. (Eds.), *Introduction to Sustainable Development*, first ed. Wiley (Chapter 1).
- Pinto, F., Franco, C., Andre, R.N., Miranda, M., Gulyurtlu, I., Cabrita, I., 2002. Co-gasification study of biomass mixed with plastic wastes. *Fuel* 3 (81), 291–297.
- Pinto, F., Franco, C., Andre, R.N., Tavares, C., Dias, M., Gulyurtlu, I., 2003. Effect of experimental conditions on co-gasification of coal, biomass and plastics wastes with air/steam mixture in a fluidized bed system. *Fuel* 15–17 (82), 1967–1976.
- PKA, 2002. PKA Pyrolysis. Available at: <http://home.tonline.de/home/PKA.DE>.
- Plastic Technology, 1994. Nissan begin recycling painted car bumpers, June, p. 96. *Pollution Issue*, 2007. Incineration, Ho:Li, Available at: pollutionissues.com.
- Ponzio, A., Kalisz, S., Blasiak, W., 2006. Effect of operating conditions on tar and gas composition in high temperature air/steam gasification (HTAG) of plastic containing waste. *Fuel Processing Technology* 87 (3), 223–233.
- Rand, T., Haukoil, J., Marxen, U., 2000. Municipal solid waste incineration: requirements for a successful project. World Bank Technical Paper No. WTP462.
- Ray, R., Bhattacharya, P., Chowdhury, R., 2004. Simulation and modelling of vegetable market wastes pyrolysis under progressive deactivation condition. *The Canadian Journal of Chemical Engineering* 82 (3), 566–579.
- Recovynyl, 2008. Application covered by Recovynyl. Available at: <http://www.recovynyl.com/coveredapplications>.

- Rittmeyer, C., Vehlouw, J., 1993. Decomposition of organohalogen compounds in municipal solid waste incineration plants. Part I: chlorofluorocarbons. *Chemosphere* 26 (12), 2129–2138.
- Rittmeyer, C., Kaese, P., Vehlouw, J., Vilohr, W., 1994. Decomposition of organohalogen compounds in municipal solid waste incineration plants. Part II: co-combustion of CFC containing polyurethane foams. *Chemosphere* 28 (8), 1455–1465.
- Rogaume, Y., Jabouille, F., Auzanneau, M., Goudeau J.C., 1999. In: *Proceedings of the 5th International Conference on Technologies and Combustion for a Clean Environment*, vol. 1. Lisbon, Portugal, pp. 345–351.
- Sas, H.J.W. 1994. Disposal of municipal solid waste: analysis of environmental effects and cost. Centre for Energy Conservation and Environmental Technology Delft, Netherlands.
- Scheirs, J., 1998. *Polymer Recycling: Science, Technology and Application*, first ed. Wiley-Blackwell.
- Shukla, S.R., Harad, A.M., 2006. Aminolysis of polyethylene terephthalate waste. *Polymer Degradation and Stability* 91 (8), 1850–1854.
- Shukla, S.R., Harad, A.M., Jawale, L.S., 2008. Recycling of waste PET into useful textile auxiliaries. *Waste Management* 28 (1), 51–56.
- Shukla, S.R., Harad, A.M., Jawale, L.S., 2009. Chemical recycling of PET waste into hydrophobic textile dyestuffs. *Polymer Degradation and Stability* 94 (4), 604–609.
- Slapak, M.J.P., Kasteren, J.M.N.V., Drinkenburg, A.A.H., 2000. Design of a process for steam gasification of PVC waste. *Resources, Conservation and Recycling* 2 (30), 81–93.
- Smolders, K., Baeyens, J., 2004. Thermal degradation of PMMA in fluidised beds. *Waste Management* 24 (8), 849–857.
- Steiner, C., Kameda, O., Oshita, T., Sato, T., 2002. EBARA's fluidized bed gasification: atmospheric 2 × 225 t/d for shredding residues recycling and two-stage pressurized 30 t/d for ammonia synthesis from waste plastics. In: *Proceedings of Second International Symposium on Feedstock Recycle of Plastics & Other Innovative Plastics Recycling Techniques*, Ostend, Belgium, 8–11 September.
- Stiles, H.N., Kandiyoti, R., 1989. Secondary reactions of flash pyrolysis tars measured in a fluidized bed pyrolysis reactor with some novel design features. *Fuel* 68 (3), 275–282.
- Strapasson, R., Amico, S.C., Pereira, M.F.R., Sydenstricker, T.H.D., 2005. Tensile and impact behaviour of polypropylene/low density polyethylene blends. *Polymer Testing* 24 (4), 468–473.
- Substances and Technologies (SubsTech), 2006. Link to plastic recycling. Available at: http://www.substech.com/dokuwiki/doku.php?id=plastics_recycling.
- Toloken, S., 1998. Computers, plastics don't mix well. In: *Waste news*; June 1st. Available at: <http://www.wasterecyclingnews.com/arcshow>.
- Troitsch, J., 1990. *International Plastics Flammability Handbook*. Hanser Publishers, Munich.
- Tukker, A., de Groot, H., Simons, L., Wiegiersma, S., 1999. *Chemical recycling of plastic waste: PVC and other resins*. European Commission, DG III, Final Report, STB-99-55 Final. Delft, the Netherlands.
- USEPA, 2002. *Municipal Solid Waste in the United States: 2000 Facts and Figures*. Executive Summary. Office of solid waste management and emergency response (5305W), EPA530-S-02-001, June. Available at: www.epa.gov.
- USEPA, 2008. *Municipal Solid Waste in the United States: 2007 Facts and Figures*. Executive summary. Office of solid waste management and emergency response (5306P), EPA530-R-08-010, November. Available at: www.epa.gov.
- Van de Velden, M., Baeyens, J., Boukis, I., 2008. Modelling CFB biomass pyrolysis reactors. *Biomass and Bioenergy* 32 (1), 128–139.
- Veit, H.M., Pereira, C., Bernardes, A.M., 2002. Using mechanical processing in recycling printed wiring board. *Journal of the Minerals, Metals and Materials Society* 54 (6), 45–47.
- Wang, H., Liu, Y., Li, Z., Zhang, X., Zhang, S., Zhang, Y., 2009. Glycolysis of poly(ethylene terephthalate) catalyzed by ionic liquids. *European Polymer Journal* 45 (5), 1535–1544.
- Weigand, E., Wagner, J., Waltenberger, G., 1996. Energy recovery from polyurethanes in industrial power plants. *Abfall Journal* 3, 40–45.
- Weissman, R., 1997. Recycling of mixed plastic waste by the Texaco gasification process. In: Hoyle, W., Karsa, D.R. (Eds.), *Chemical Aspects of Plastics Recycling*. The Royal Society of Chemistry Information Services, Cambridge, UK.
- Westerhout, R.W.J., Kuipers, J.A.M., van Swaaij, W.P.M., 1998. Experimental determination of the yield of pyrolysis products of polyethylene and polypropylene. Influence of reaction conditions. *Industrial & Engineering Chemistry Research* 37 (3), 841–847.
- WGT, 2002. Waste Gas Technology Energy from Waste. Available at: <http://www.wgtuk.com/ukindex.html>.
- Williams, E.A., Williams, P.T., 1997. The pyrolysis of individual plastics and plastic mixture in a fixed bed reactor. *Journal of Chemical Technology and Biotechnology* 70 (1), 9–20.
- Wong, H.W., Broadbelt, L.J., 2001. Tertiary resource recovery from waste polymers via pyrolysis: neat and binary mixture reactions of polypropylene and polystyrene. *Industrial and Engineering Chemistry Research* 40 (22), 4716–4723.
- Wu, S., Su, M., Baeyens, J., 1997. The fluidized bed pyrolysis of shredded tyres: the influence of carbon particles, humidity, and temperature on the hydrodynamics. *Powder Technology* 93 (3), 283–290.
- Xiao, C., Laurence, A., Biddle, M.B., 1999. Electrostatic separation and recovery of mixed plastics. In: *Society of Plastics Engineers (SPE) Annual Recycling Conference (ARC)*, Dearborn, Michigan (US).
- Xiao, R., Jin, B., Zhou, H., Zhong, Z., Zhang, M., 2007. Air gasification of polypropylene plastic waste in fluidized bed gasifier. *Energy Conversion and Management* 48, 778–786.
- Xiao, G., Ni, M., Chi, Y., Jin, B., Xiao, R., Zhong, Z., Huang, Y., 2009. Gasification characteristics of MSW and an ANN prediction model. *Waste Management* 29 (1), 240–244.
- Yamaye, M., Nago, Y., Sasaki, M., Tsuru, T., Mukae, K., Yoshinaga, T., Murayama, R., Tahara, C., 2006. Chemical recycling of polyesters. One-pot-two-step conversion of poly(ethylene 2,6-naphthalenedicarboxylate) and poly(tetramethylene terephthalate), producing the corresponding hydroxamic acids and hydrazides. *Polymer Degradation and Stability* 91 (9), 2014–2021.
- Yang, J., Gupta, M., Roy, X., Roy, C., 2004. Study of tire particle mixing in a moving and stirred bed vacuum pyrolysis reactor. *The Canadian Journal of Chemical Engineering* 82 (3), 510–519.
- Yassin, L., Lettierim, P., Simons, S.J.R., Germana, A., 2005. Energy recovery from thermal processing of waste: a review. *Engineering Sustainability (Proc ICE)* 158 (ES2), 97–103.
- Yoshioka, T., Gause, G., Eger, C., Kaminsky, W., Okuwaki, A., 2004. Pyrolysis of poly(ethylene terephthalate) in a fluidized bed plant. *Polymer Degradation and Stability* 86 (3), 499–504.
- Zanzi, R., Sjöström, K., Björnbom, E., 1996. Rapid high-temperature pyrolysis of biomass in a free fall reactor. *Fuel* 75 (5), 545–550.
- Zanzi, R., Sjöström, K., Björnbom, E., 2002. Rapid pyrolysis of agricultural residues at high temperature. *Biomass and Bioenergy* 23 (5), 357–366.
- Zevenhoven, R., Axelsen, E.P., Elomaa, M., Kilpinen, P., Hupa, M., 2003. Final Report. Finnish National Technology Agency, Helsinki, pp. 104–109.
- Zia, K.M., Bhatti, H.N., Bhatti, I.A., 2007. Methods for polyurethane and polyurethane composites, recycling and recovery: a review. *Reactive & Functional Polymers* 67 (8), 675–692.
- Zolezzi, M., Nicoletta, C., Ferrara, S., Iacobucci, C., Rovatti, M., 2004. Conventional and fast pyrolysis of automobile shredder residues (ASR). *Waste Management* 24 (7), 691–699.